

PARTS LIST

Indian Scout

1920-1921-1922-1923-1924

1925-1926

FREW'S CYCLE & MOTOR WORKS,
CR. LORD AND PARRY STREETS,
EAST PERTH.



Indian Motorcycle Company

Springfield, Massachusetts, U. S. A.

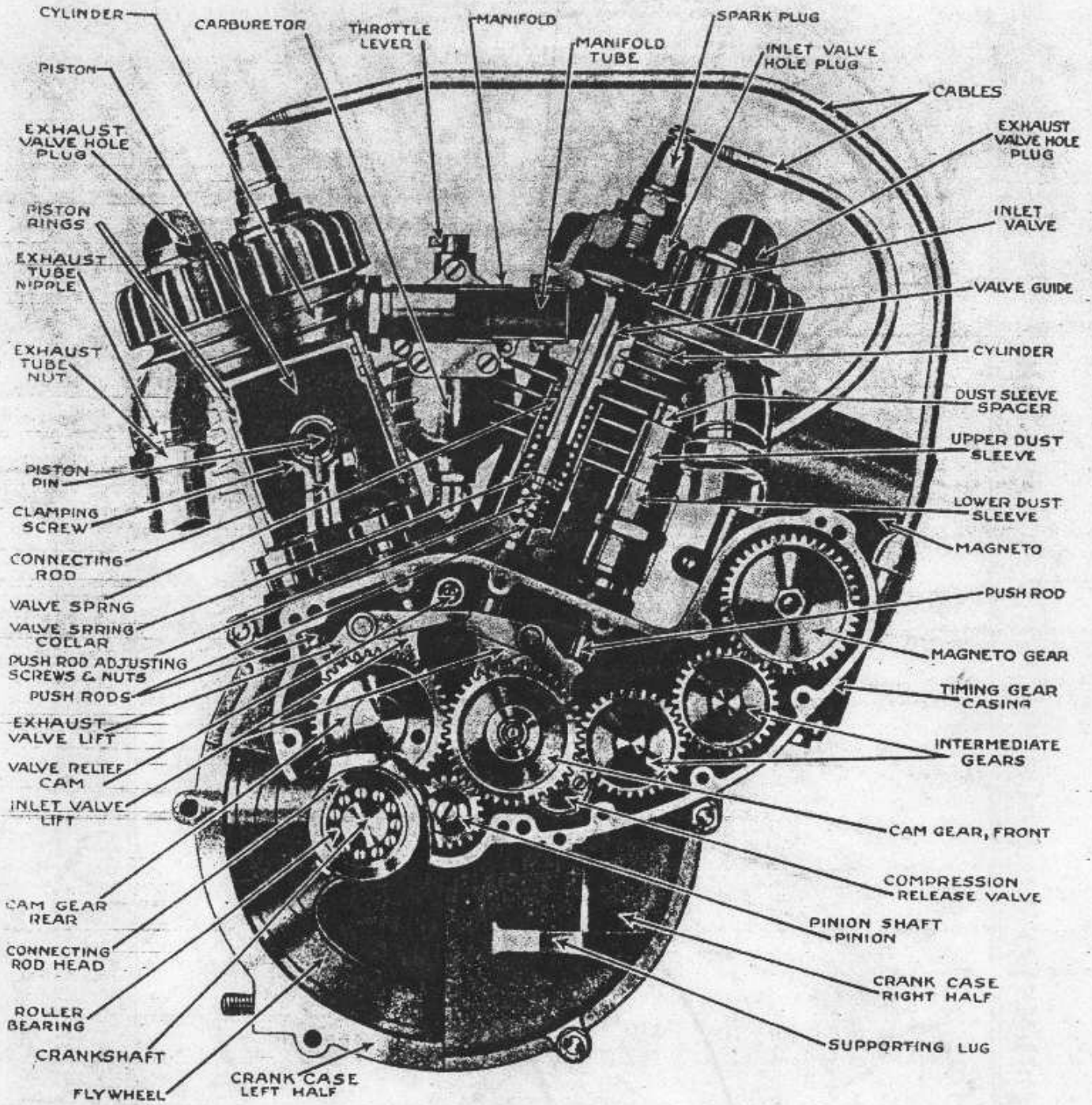

Sectional View G-20 Motor

This list covers spare parts for the 1920-1921-1922-1923-1924-1925-1926 Model G known as the INDIAN SCOUT. Parts for the CHIEF and PRINCE models will be found in separate Parts Lists.

READ THIS CAREFULLY

To distinguish various models:

YEAR	MODEL	LETTER IN MOTOR NUMBER
1920	G	R (Example: 50R000)
1921	G	S (Example: 50S000)
1922	G	T (Example: 50T000)
1923	G	V (Example: 50V000)
1924	G	X (Example: 50X000)
1925	G	Y (Example: 50Y000)
1926	G	AG (Example: AG100)

EXPLANATION OF LIST

In this list will be found numerous parts common to the Model N. In such cases they will bear the same number as in the POWERPLUS Parts List. (Example: N-4, Fly wheel thrust washer. Found in both Parts Lists under the same number.)

The letter "S" before the part number means that the part is common to all SCOUT models unless otherwise specified. (Example: S-56, Driving Shaft.)

The letter "R" after the part number means that the part is used on 1922 models. (Example: S-1750RX Frame for 1922 SCOUT.)

The letter "S" after the part number means that the part is used on 1923 models. (Example: S2450SXI, Gasoline tank for 1923 SCOUT.)

The letter "T" after the part number means that the part is used on 1924 models unless otherwise stated. (Example: S1550TX, Front fork complete for 1924 SCOUT.)

The letter "U" after the part number means that the part is used on 1925 models. (Example: S370U Front cylinder for 1925 SCOUT.)

The letter "V" after the part number means that this part is used on 1926 models. (Example: S373V, Cylinder rear, 1926.)

USE PART NUMBER WHEN ORDERING. DO NOT ORDER BY FACTORY NUMBER

The same factory number covers several different parts in many cases. Therefore, use the part number for each item wanted.

In telegraphing or cabling orders, it will be convenient and economical to use the code words as, where desirable, the code words can be joined to any five-letter code, thus giving a ten-letter word.

In such cases when the order can be wired within ten words, use part number to avoid errors in transmitting messages.

STANDARD, AND WILL BE SENT UNLESS OTHERWISE SPECIFIED

PARTS ORDER BLANKS should be used when ordering. We supply these free on request. Confusion and delay frequently arise by not using these blanks.

TERMS

We do not open accounts except with our regularly established selling agents. Therefore, all individual orders must be accompanied by cash, without exception. This is not to be taken as a reflection on your personal credit: it is simply to avoid our carrying on the books a multitude of small accounts, the labor of which would in many cases cost more than the parts ordered.

In establishing this rule, time is saved which is an advantage to the person ordering the parts.

ALL C. O. D. ORDERS must be accompanied by sufficient remittance to cover transportation charges.

We are not responsible for goods after once shipped. For goods lost or damaged in express and freight shipments, claims should be made by the consignee.

We do not guarantee the delivery of Parcel Post shipments. All goods sent in this manner are at the consignee's risk. No Parcel Post shipments are sent forward insured unless so specified on your order.

CLAIMS FOR SHORTAGE. Each shipment is accompanied by a Packing Slip. In cases where parts check short, this Packing Slip MUST be returned for our inspection or no adjustment will be made.

PRICES ARE SUBJECT TO CHANGE WITHOUT NOTICE.

REPLACEMENTS

Dealers and riders in many instances, when parts are broken, take it for granted that said parts are replaceable under our guarantee. Such is not the case, and parts sent in to us to be replaced are subject to our inspection for approval or rejection.

No parts will be replaced gratis which have shown defects unless the parts are returned to the dealer from whom the machine has been purchased, or to the factory.

GOODS RETURNED

Do not return any goods without our permission in writing. All carrying charges must be prepaid or otherwise we positively refuse to accept them.

When returning goods to us, either for repairs or replacement, in all instances a letter giving full and detailed particulars should be sent us.

WARNING

In keeping your machine at its top efficiency, it is mighty important that only genuine INDIAN parts are used.

The spurious INDIAN parts now being marketed trade on the INDIAN good name and entirely disregard the value and service the owner is entitled to.

Chemical analysis shows that counterfeit INDIAN parts on the market are in every instance made of material inferior in quality to that used by us. Among the many parts we have examined, we have found bearing bronze only half the hardness of INDIAN metal. Valves are made from cold rolled steel instead of chrome nickel steel and case hardened parts so brittle as to be utterly unsafe.

Bear in mind the strain to which every part of the machine is subjected when running at high speed or on rough roads. Think of the possibilities of serious injury to yourself and wreckage of your machine from breakage of a vital part of counterfeit manufacture.

Is the risk worth the saving of a few cents more for the price of a genuine part and safety?

The market is flooded with inferior material to fit INDIAN machines, therefore insist on genuine INDIAN parts.

Remember also the guarantee becomes void immediately when a machine is fitted with counterfeits.

GUARANTEE

1. All new INDIAN MOTOCYCLES, Sidecars and Component Parts are guaranteed to be free from defects in workmanship and material. Our obligation under this Guarantee is limited to the replacement without charge of any part or parts which shall, within ninety days from the date of the original sale by the Dealer, prove to be defective and which shall be promptly returned to us, transportation charges prepaid, for our examination and decision.
2. This Guarantee shall be terminated by the alteration of our construction in any way whatsoever, by the use of devices not approved by us, by the use of any but genuine INDIAN Parts for repair or replacement or by the subjecting of the Motorcycle to misuse, abuse or neglect.
3. We do not guarantee any parts of equipment or specialties not of our own manufacture, such as Tires, Magnetos, Saddles, etc. These parts are guaranteed by their respective manufacturers and, should they develop defects, should be sent direct to them.
4. When Motorcycles or assembled parts, in which defective parts are to be replaced, are sent to us, a reasonable charge for labor will be made.
5. This Guarantee is given by us in lieu of all other guarantees, expressed or implied, and all other obligations or liabilities on our part. The purchase of any INDIAN MOTOCYCLE Sidecar or Component Part signifies acceptance by the purchaser of each of the provisions hereof. We neither assume nor authorize any other person to assume for us any other liability in connection with the sale or use of INDIAN MOTOCYCLES, Sidecars or Component Parts.
6. INDIAN MOTOCYCLES, Sidecars and Component Parts, sold by other than our recognized Dealers are sold without our Guarantee, unless otherwise provided.
7. When sending in parts for replacement, customer must tag same with his name and address. A letter giving full and detailed particulars must be sent to us in each case, giving the engine number to avoid delay in identifying the consignment.

SERVICE

The sale of an INDIAN MOTOCYCLE does not mark the close of a transaction, but the beginning. Only through the co-operation of the dealer and his factory by the rendering of intelligent advice to the rider and mechanical attention to his machine when necessary, will the greatest satisfaction, pleasure and efficiency of operation be obtained. The purchaser of an INDIAN MOTOCYCLE commands the unapproached service facilities of factory branches supplemented by the service departments of our 2000 dealers. This organization maintained at great expense solely for the benefit of INDIAN riders offers prompt service on all orders sent to the factory.

Prices subject to change without notice.

An amount equal to the amount of any excise or sales tax which may be payable, is to be added to all net prices based on this list.

Printed in U. S. A.

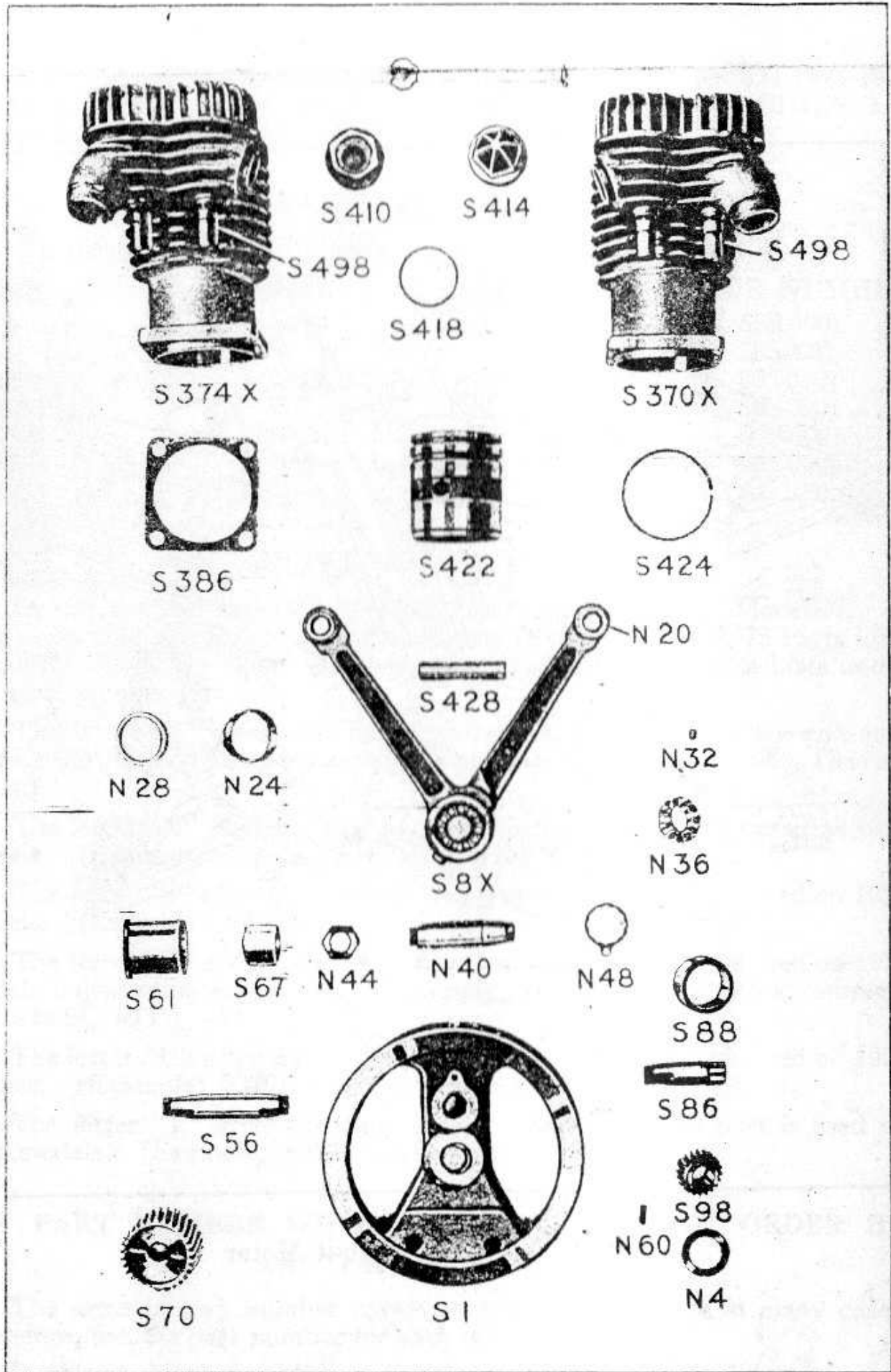

Fly Wheel and Crank Motion Group
Cylinder and Piston Group

Code	Factory No.	Part No.	DESCRIPTION	No. Used	Price Each
Abada	20C234	S1	Fly wheel	2	\$3.75
Abao	16A143	N4	Fly wheel thrust washer	4	.10
Abaxg	20C135/134X1	S8X	Connecting rod inner and outer complete with bushings and bearings	1	11.50
Abche	20C135X	S12X	Connecting rod inside with upper bushing and roller bearing bushing (rear)	1	3.25
Abeca	20C135	S12	Connecting rod (rear)	1	2.30
Abeme	20C134X	S16X	Connecting rod outside with bushings (front)	1	4.50
Abeyf	20C134	S16	Connecting rod (front)	1	3.75
Abido	16A143	N20	Connecting rod upper bushing	2	.40
Abihg	16A12	N24	Connecting rod roller bearing bushing (rear)	1	.40
Abioq	16A11	N28	Connecting rod roller bearing bushing (front)	2	.30
Abkuw	16A15	N32	Connecting rod roller bearing roller	44	.04
Ablus	16A14	N36	Connecting rod roller bearing retainer	4	.40
Abocl	16A16	N40	Crank shaft	1	.90
Aboph	D180	N44	Crank shaft nut	2	.10
Abpyo	D200	N48	Crank shaft nut lock washer	2	.03
Abuex	16A185	N52	Crank shaft nut lock washer screw	2	.01
Abuko	20B96	S56	Driving shaft	1	.80
Acacq	F235	N60	Driving shaft fly wheel key	1	.05
Aboph	D180	N44	Driving shaft nut	1	.10
Abpyo	D200	N48	Driving shaft nut lock washer	1	.03
Abuex	16A185	N52	Driving shaft nut lock washer screw	1	.01
Acafe	20B97	S61	Driving shaft roller bearing housing	1	1.00
Abkuw	16A15	N32	Driving shaft roller bearing roller	22	.04
Acaji	20B98	S65	Driving shaft roller bearing roller retainer	2	.40
Acasa	20B99	S67	Driving shaft roller bearing spacer	1	.15
Acdle	20B46	S70	Driving shaft pinion	2	2.75
Acege	20B131S	S73	Driving shaft pinion key	1	.03
Aboph	D180	N44	Driving shaft pinion nut	1	.10
Acejo	20B47	S77	Driving shaft pinion nut lock washer	1	.02
Aceku	20B37	S81	Driving shaft pinion thrust washer .061 thick.	1	.12
Acepl	20B812	S81A	Driving shaft pinion thrust washer .046 thick.	1	.12
Acesh	20B813	S81B	Driving shaft pinion thrust washer .051 thick.	1	.12
Acewa	20B814	S81C	Driving shaft pinion thrust washer .056 thick.	1	.12
Acipo	22B254	S83	Driving shaft pinion cork washer	1	.02
Acisp	20B100	S86	Pinion shaft	1	1.00
Acacq	F235	N60	Pinion shaft fly wheel key	1	.05
Aboph	D180	N44	Pinion shaft fly wheel nut	1	.10
Abpyo	D200	N48	Pinion shaft fly wheel nut lock washer	1	.03
Abuex	16A185	N52	Pinion shaft fly wheel nut lock washer screw	1	.01
Acksj	20B101	S88	Pinion shaft roller bearing housing	1	.75
Acoba	16A25	N158	Pinion shaft roller bearing housing washer	1	.15

Order by Number.

Give Motor Number.

Use order blanks which will be furnished on application

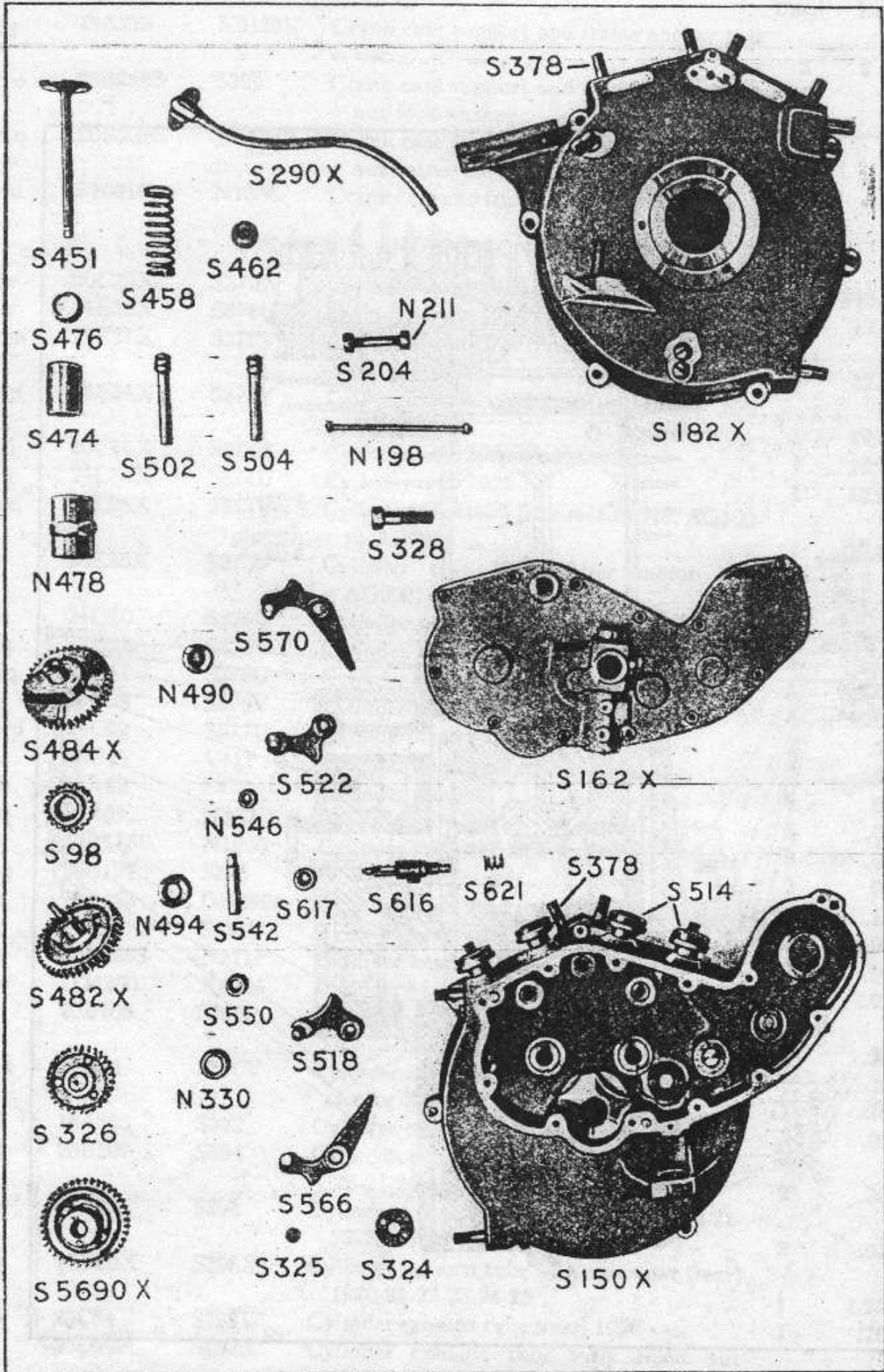

Crank Case and Valve Group 1920-1924

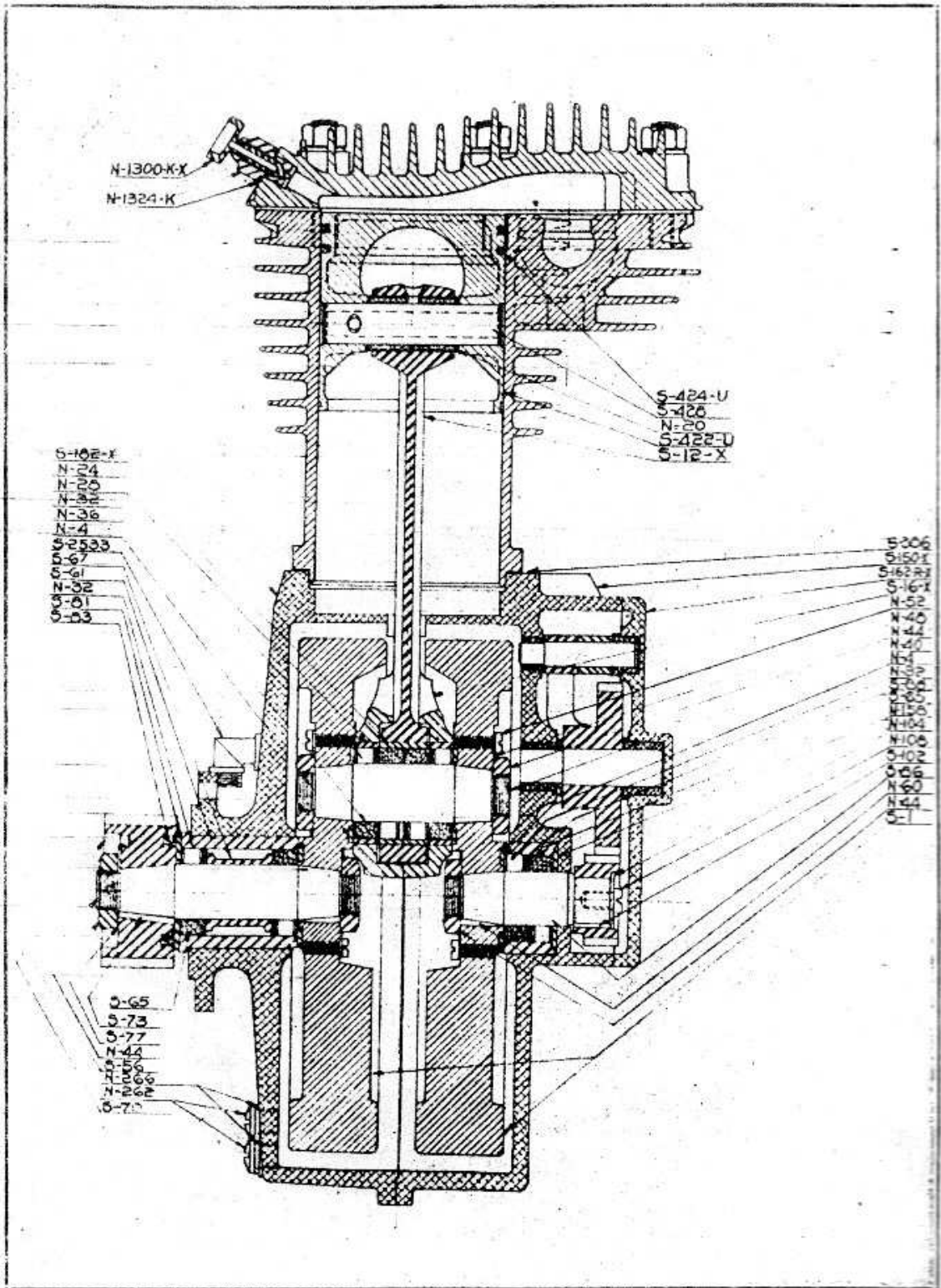

Sectional View 1926 Scout Motor

INDIAN MOTORCYCLE PARTS LIST

Code	Factory No.	Part No.	DESCRIPTION	No. Used	Price Each
Bafuz	16A406	S91	Pinion shaft roller bearing washer shim (.005 thick)		\$.03
Balyd	16A407	S92	Pinion shaft roller bearing washer shim (.010 thick)		.03
Abkuw	16A15	N32	Pinion shaft roller bearing roller	22	.04
Acaji	20B98	S65	Pinion shaft roller bearing roller retainer	2	.40
Acariq	20B104	S98	Pinion shaft pinion	1	.90
Acshy	20B130S	S102	Pinion shaft pinion key	1	.02
Acteq	16A52	N104	Pinion shaft pinion washer	1	.03
Actzi	16A83	N108	Pinion shaft pinion washer screw	1	.03

CRANK CASE GROUP

Acuka	20D11X3	S150X	Crank case right half assembly	1	\$18.00
Acwax	20B111	S153	Crank case right half oil deflector	1	.05
Acwoy	20D13X	S182X	Crank case right half gear case cover assembly (type A) 1920-21	1	8.00
Acwio	22D75X	S162RX	Crank case right half gear case cover assembly (type B) 1922-23-24-25-26	1	6.00
Adaej	20C20	S166	Crank case right half gear case cover gasket	1	.10
Adaub	16A23	N170	Crank case right half gear case cover screw	12	.05
Adbyo	16A68	N174	Crank case right half gear case cover dowel pin	3	.03
Addli	20D12X1	S182X	Crank case left half assembly	1	10.00
Adeho	16A147	N198	Crank case top center bolt	1	.10
Adest	A1210	N202	Crank case top center bolt nut	2	.03
Adfax	20B147	S204	Crank case bolt	6	.05
Adfy	19A58	N211	Crank case bolt nut	12	.03
Adicq	19B114S	N214	Crank case bolt nut lock washer	12	.01
Afbac	20B45	S216	Crank case transmission stud	4	.05
Afscw	20B228S	N211P	Crank case transmission stud nut	4	.03
Afftu	19B115S	N1960	Crank case transmission stud lock washer	4	.01
Adbyo	16A68	N174	Crank case transmission dowel pin	2	.03
Afiko	E35060	N262	Crank case oil drain screw	1	.05
Afisu	E35061	N266	Crank case oil drain screw leather washer	1	.01
Afiko	E35060	N262	Crank case oil level screw	1	.05
Afisu	E35061	N266	Crank case oil level screw leather washer	1	.01
Afkop	20B280X	S290X	Crank case air relief tube with elbow	1	.75
Afnug	20B112	S292	Crank case air relief tube elbow	1	.50
Afpeb	A10470	N4026	Crank case air relief tube elbow screw	2	.03
Afpru	20B102	S324	Crank case compression release valve housing 1922	1	.25
Afpuh	23B67	S324S	Crank case compression release valve housing 1923-24-25-26	1	.25
Afung	20B103	S325	Crank case compression release valve disc	1	.01
Afuzu	E19867	N2288	Crank case compression release valve screw	2	.02
Afyfe	20B340S	S2207	Crank case and frame anchor bolt 1920-21-22	2	.10
Cilru	22B261	S2207R	Crank case and frame anchor bolt 1923-24-25-26	2	.10
Afzec	22B493	S327	Crank case support and fibre washer	2	.01

Order by Number.

Give Motor Number.

Use order blanks which will be furnished on application

Code	Factor No.	Part No.	DESCRIPTION	No. Used	Price Each
Afaig	18A215	N9129K	Crank case support and frame anchor bolt nut	2	\$.05
Agayo	20B259S	S329	Crank case support and frame anchor bolt nut lock washer	2	.01
Agduq	20B238S	N1694P	Crank case support and frame anchor bolt nut cotter pin	1	.01
Agedo	B16610	N1688	Crank case and frame anchor bolt washer	2	.03
CYLINDER AND PISTON GROUP					
Agete	20C29X	S370X	Cylinder front 1920-21-22-23-24	1	\$16.00
Agibo	24E33X	S370U	Cylinder front 1925	1	12.00
Bagom	25E27X	S370V	Cylinder front 1926 (For motors No. AG100 to AG900)	1	12.00
Bahim	26E34X	S371V	Cylinder front 1926 (After motor No. AG900)	1	12.00
Agimi	20C30X	S374X	Cylinder rear 1920-21-22-23-24	1	16.00
Aginx	24E34X	S374U	Cylinder rear 1925	1	12.00
Bahyc	25E28X	S374V	Cylinder rear 1926 (For motors No. AG100 to AG900)	1	12.00
Bajin	26E35X	S373V	Cylinder rear 1926 (After motor No. AG900)	1	12.00
Agloq	24D10	S375U	Cylinder head front 1925	1	4.00
Bajuq	25D24	S375V	Cylinder head front 1926	1	4.00
Agmiq	24D11	S376U	Cylinder head rear 1925	1	4.00
Balty	25D25	S376V	Cylinder head rear 1926	1	4.00
Agmyd	24C32	S377U	Cylinder head gasket 1925	2	.25
Abtas	25C45	V411	Cylinder head gasket 1926	2	.25
Aglyb	16A62	S378	Cylinder stud	8	.05
Agocq	16A61	N382	Cylinder stud nut	8	.08
Afftu	19B115S	N1960	Cylinder stud nut lock washer	8	.01
Agpaq	20B127	S386	Cylinder seat gasket	2	.02
Agreq	16A159	GH4966	Cylinder head stud long 1925-26	1	.10
Agrod	24B98	S413U	Cylinder head stud short 1925-26	11	.05
Afcek	20B228S	N211P	Cylinder head stud nut 1925-26	12	.03
Agnye	D24250	N4244	Cylinder head stud nut washer 1925-26	11	.02
Agric	20B108	S390	Cylinder carburetor tube nipple 1920-21- 22-23-24-25 and early 1926	2	.25
Bamex	26B24	S390V	Cylinder carburetor tube nipple 1926 (After motor No. AG900)	2	.25
Aguni	16A395	S392	Cylinder carburetor tube nipple rivet	2	.01
Ahabf	20B109	S394	Cylinder exhaust tube nipple 1920-21-22- 23-24-25	2	.30
Ahana	16A396	S396	Cylinder exhaust tube nipple rivet 1920-21- 22-23-24-25	2	.01
Ahdeq	20D30X	S398X	Cylinder exhaust tube with union nut (rear) 1920-21-22-23-24-25	1	1.25
Banaw	25C54	S398V	Cylinder exhaust tube (rear) 1926	1	.75
Aheru	20D29X	S402X	Cylinder exhaust tube with union nut (front) 1920-21-22-23-24-25	1	1.25
Bamzu	25C53	S402V	Cylinder exhaust tube (front) 1926	1	.70

Order by Number.

Give Motor Number.

Use order blanks which will be furnished on application

Code	Factory No.	Part No.	DESCRIP	No. Used	Price Each
Algia	D24305	N1634	Cylinder exhaust tube screw 1926	2	\$.03
Akosh	10B112S	N2808	Cylinder exhaust tube screw lock washer 1926	2	.01
Ahist	20B110	S406	Cylinder exhaust tube union nut	2	.25
Ahldu	20B73	S410	Cylinder intake valve hole plug 1920-21-22-23-24	2	.70
Ahvsu	20B74	S414	Cylinder exhaust valve hole plug 1920-21-22-23-24	2	.60
Ajaco	20B75	S418	Cylinder exhaust valve hole plug gasket 1920-21-22-23-24	4	.05
Ajbeu	25C59	S422U	Piston (see note)	2	2.25
Ajcid	20C250	S424	Piston ring 1920-21-22-23-24	4	.30
Ajcly	23C52	S424U	Piston ring 1925-26	4	.30
Ajdiq	20B503	S428	Piston cross head pin	2	.40
Ajear	16A140	N432	Piston cross head pin dowel pin	2	.05

Note: For purpose of standardization, the 1925 type piston taking $\frac{1}{8}$ " rings will be supplied on all orders for Scout pistons

Accordingly when ordering Scout pistons for models previous to 1925, rings also should be ordered

INLET AND EXHAUST VALVE GROUP

Ajeve	20B168	S450	Inlet valve 1920-21-22-23-24	2	\$1.25
Ajnox	25B186	S450U	Intake valve 1925-26	2	1.25
Ajfia	20B71	S451	Exhaust valve 1920-21-22-23-24	2	1.25
Ajoab	25B185	S451U	Exhaust valve 1925-26	2	1.25
Ajful	20B226	S458	Inlet and exhaust valve spring 1920-21-22-23-24	4	.10
Ajgaw	26B143	N458	Inlet and exhaust valve spring 1925-26	4	.15
Ajgey	20B78	S462	Inlet and exhaust valve spring collar	4	.05
Ajgoq	20B79	S466	Inlet and exhaust valve spring collar key	8	.05
Ajhag	20B77	S474	Inlet and exhaust valve upper dust sleeve 1920-21-22-23-24	4	.15
Akofa	25B275	S474U	Inlet and exhaust valve upper dust sleeve 1925	4	.15
Ajhix	16A59	N474	Inlet and exhaust valve upper dust sleeve 1926	4	.20
Ajhok	20B76	S476	Inlet and exhaust valve upper dust sleeve spacer 1920-21-22-23-24	4	.10
Ajhuq	16A60	N478	Inlet and exhaust valve lower dust sleeve	4	.45
Ajimo	20B156X	S482X	Inlet and exhaust valve cam with shaft and oil pump worm (front) 1920-21-22-23-24	1	3.00
Akruq	20B1013X	S482UX	Inlet and exhaust valve cam with shaft (front) 1925-26	1	3.00
Ajkil	20B858	S483	Inlet and exhaust cam shaft with oil pump worm (front)	1	.70
Ajkun	20B157X	S484X	Inlet and exhaust valve cam with shaft (rear) 1920-21-22-23-24	1	2.75
Aktly	20B1014X	S484UX	Inlet and exhaust valve cam with shaft (rear) 1925-26	1	2.75
Ajmop	20B84	S485	Inlet and exhaust valve cam shaft (rear)	1	.35

Order by Number.

Give Motor Number.

Use order blanks which will be furnished on application

Code	Factory No.	Part No.	DESCRIPTION	No. Used	Price Each
Ajner	16A28	N490	Inlet and exhaust cam crank case bushing	2	\$.30
Ajnip	16A29	N494	Inlet and exhaust cam gear case cover bushing (Type A)	2	.30
Ajnip	16A29	N494	Inlet and exhaust cam gear case cover bushing (rear) (Type B)	1	.30
Ajodi	22B511	S494R	Inlet and exhaust cam gear case cover bushing (front) (Type B)	1	.30
Ajomq	20B72	S498	Inlet and exhaust valve guide 1920-21-22-23-24	4	.50
Chome	25B262	S498U	Inlet and exhaust valve guide 1925 (Screw in type)	4	.50
Akunf	25B187	S498V	Inlet and exhaust valve guide 1925-26 (Push in type)	4	.50
Banyb	26B148	S501V	Inlet valve push rod (front)	1	.25
Ajoru	20B80	S502	Exhaust valve push rod (front)	1	.25
Baccu	26B149	S503V	Inlet valve push rod (rear)	1	.25
Ajpan	20B81	S504	Exhaust valve push rod (rear)	1	.25
Ajphi	16A55	N506	Intake and exhaust valve push rod adjusting screw	4	.05
Ajpie	16A56	N510	Intake and exhaust valve push rod adjusting screw lock nut	4	.03
Ajram	20B82	S514	Intake and exhaust valve push rod guide	4	.60
Ajrif	20B87X	S518X	Intake valve lift with roller (front)	1	1.00
Ajruv	20B88X	S522X	Intake valve lift with roller (rear)	1	1.00
Ajsef	20B89X	S566X	Exhaust valve lift with roller (front)	1	1.00
Ajsov	20B90X	S570X	Exhaust valve lift with roller (rear)	1	1.00
Ajsue	A5060	N574	Inlet and exhaust valve lift roller	4	.12
Ajubu	A5070	N578	Inlet and exhaust valve lift roller rivet	4	.03
Ajume	20B91	S542	Inlet and exhaust valve lift shaft	2	.20
Ajvat	16A37	N546	Inlet and exhaust valve lift shaft crank case bushing	2	.20
Ajvyc	20B92	S550	Inlet and exhaust valve lift shaft gear case cover bushing	2	.20
Ajwet	20B93	S616	Exhaust valve relief cam 1920-21-22-23	1	1.00
Ajyeb	24B20	S616T	Exhaust valve relief cam 1924-25-26	1	1.00
Ajvat	16A37	N546	Exhaust valve relief cam crank case bushing	1	.20
Ajyuf	20B94	S617	Exhaust valve relief cam gear case cover bushing	1	.25
Akacu	20B95	S618	Exhaust valve relief cam cork washer	1	.01
Akadj	20B175	S621	Exhaust valve relief cam spring	1	.02
Akain	18A27	N604K	Exhaust valve relief cam lever 1920-21-22	1	.45
Bosses	20B474	N604P	Exhaust valve relief cam lever 1923	1	.45
Alcaq	24B21	S604T	Exhaust valve relief cam lever 1924-25-26	1	.20
Akapo	A28160	N2252	Exhaust valve relief cam lever nut	1	.03
Akazi	A3230	N614	Exhaust valve relief cam lever nut cotter pin	1	.01
Akbiq	20C130X	S622X	Exhaust valve relief hand lever complete 1920-21	1	5.00
Akbry	22C89X	S622RX	Exhaust valve relief hand lever complete with cable 1922	1	6.00

Order by Number.

Give Motor Number.

Use order blanks which will be furnished on application

	No.	No.	DESCRIPTION	No. Used	Price Each
Aldsi	24B174X	S022SX	Exhaust valve relief rod and knob 1923-24-25-26	1	\$.75
Human	2771	N623	Exhaust valve relief rod knob 1923-24-25-26	1	.25
Budder	19B86	N624P	Exhaust valve relief rod spring 1923	1	.03
Alegi	24B70	S621T	Exhaust valve relief rod spring 1924-25-26	1	.03
Akazi	A3230	N614	Exhaust valve relief rod cotter pin 1923-24-25-26	1	.01
Fossiled	C19900	N2292	Exhaust valve relief rod clevis 1923	1	.25
Fostered	A26190	N2294	Exhaust valve relief rod clevis pin 1923	1	.05
Akazi	A3230	N614	Exhaust valve relief rod clevis pin cotter pin 1923	1	.01
Fragiled	B3280	N2302	Exhaust valve relief rod nut 1923-24-25-26	1	.03
Abirf	23B81	S623S	Exhaust valve relief rod guide 1923-24	1	.15
Aldye	25B142	V2468	Exhaust valve relief rod guide 1925-26	1	.15
Abisl	23B12	S625S	Exhaust valve relief rod guide tank screw 1923-24	2	.03
Alemo	19B113S	N736	Exhaust valve relief rod guide tank screw lock washer 1923-24	2	.01
Alehu	24B46X	S627TX	Exhaust valve relief rod lower fitting 1924-25-26	1	.15
Alerq	24B47	S628T	Exhaust valve relief rod lower fitting stud 1924-25-26	1	.02
Akazi	A3230	N614	Exhaust valve relief rod lower fitting stud cotter pin 1924-25-26	1	.01
Akcey	16B120	S624	Exhaust valve relief hand lever 1920-21	1	.75
Akcru	22C46	N4006R	Exhaust valve relief hand lever 1922	1	1.00
Akcvl	16A315	S626	Exhaust valve relief hand lever stud 1920-21-22	2	.20
Akdax	A22210	N2758	Exhaust valve relief hand lever stud nut 1920-21-22	2	.03
Akeas	22B191	N4015R	Exhaust valve relief hand lever handle bar bracket 1922	1	.50
Akemq	A7140	N752	Exhaust valve relief hand lever handle bar bracket rivet 1922	2	.01
Akeon	22B192	N4017R	Exhaust valve relief hand lever handle bar bracket block 1922	1	.25
Akesu	22B193	N4019R	Exhaust valve relief hand lever handle bar bracket block pin 1922	1	.10
Aketh	16A316	S629	Exhaust valve relief hand lever cable casing upper stop 1920-21	1	.35
Akglu	22B194	N4018R	Exhaust valve relief hand lever cable casing upper stop 1922	1	.20
Akibe	16A314	S633	Exhaust valve relief hand lever cable casing upper stop bushing 1920-21	1	.05
Akidl	17A140	S635	Exhaust valve relief hand lever handle bar clamp 1920-21-22	1	.25
Akigs	20B419	S637	Exhaust valve relief cable (52 1/2" long) 1920-21-22	1	.30
Akimb	D24315	N4033	Exhaust valve relief cable end sleeve 1920-21-22	2	.01

Order by Number.

Give Motor Number.

Use order blanks which will be furnished on application

Code	Factory No.	Part No.	DESCRIPTION	No. Used	Price Each
Akinu	20B420	S639	Exhaust valve relief cable casing (45" long) 1920-21-22	1	\$.75
Aknej	D24325	N4042	Exhaust valve relief cable casing end cap 1920-21-22	2	.05
Akodo	17A181	N4046	Exhaust valve relief cable casing handle bar and frame clip 1920-21-22	3	.05
Akoel	D24335	N4054	Exhaust valve relief cable casing lower stop 1920-21-22	1	.15
Akdax	A22210	N2758	Exhaust valve relief cable casing lower stop nut 1920-21-22	2	.03
Akoji	20B343	S641	Exhaust valve relief cable casing lower stop bracket 1920-21-22	1	.15
Aspeb	A10470	N4026	Exhaust valve relief cable casing lower stop bracket screw 1920-21-22	3	.03
Akosh	19B112S	N2808	Exhaust valve relief cable casing lower stop bracket screw lock washer 1920-21-22	3	.01
Akphu	20B505	S645	Exhaust valve relief cable spring 1920-21-22	1	.05
Akqua	D24365	N4093	Exhaust valve relief cable spring dust cap 1920-21-22	1	.25
Akren	E24370	N4094	Exhaust valve relief cable spring socket 1920-21-22	1	.25
Akrop	D24375	S649	Exhaust valve relief cable spring socket pin 1920-21-22	1	.05
Akazi	A3230	N614	Exhaust valve relief cable spring socket pin cotter pin 1920-21-22	1	.01

SPARK PLUG GROUP

Akryz	A13000X	S630X	Spark plug complete with gasket	2	\$1.00
Aksoq	A13010	N1332	Spark plug gasket	2	.05
Aktia	A13030	N638	Spark plug and cable clips	2	.05

MUFFLER GROUP

Akumx	20C73X1	S700X1	Muffler assembly 1920-21-22-23-24-25	1	\$3.50
Barlq	25C55X	S700VX1	Muffler assembly 1926	1	3.50
Batzi	20B325	S704	Muffler front clip	1	.10
Bejia	25B388	S706V	Muffler front clip strap 1926	1	.05
Noveled	F35820	N4262	Muffler front clip strap screw	1	.05
Akapo	A28160	N2252	Muffler front clip strap nut	1	.03
Alfow	20B326	S728	Muffler rear clip	1	.10
Aljia	D24305	N1634	Muffler rear clip clamping screw	1	.03
Aljyo	17A365	S733	Muffler rear clip clamping screw nut	1	.03
Akosh	19B112S	N2808	Muffler rear clip clamping screw lock washer	1	.01
Aloni	B22200	N9212	Muffler rear clip anchor screw	1	.05
Akapo	A28160	N2252	Muffler rear clip anchor screw nut	1	.03
Alemo	19B113S	N736	Muffler rear clip anchor screw nut lock washer	1	.01

Order by Number.

Give Motor Number.

Use order blanks which will be furnished on application

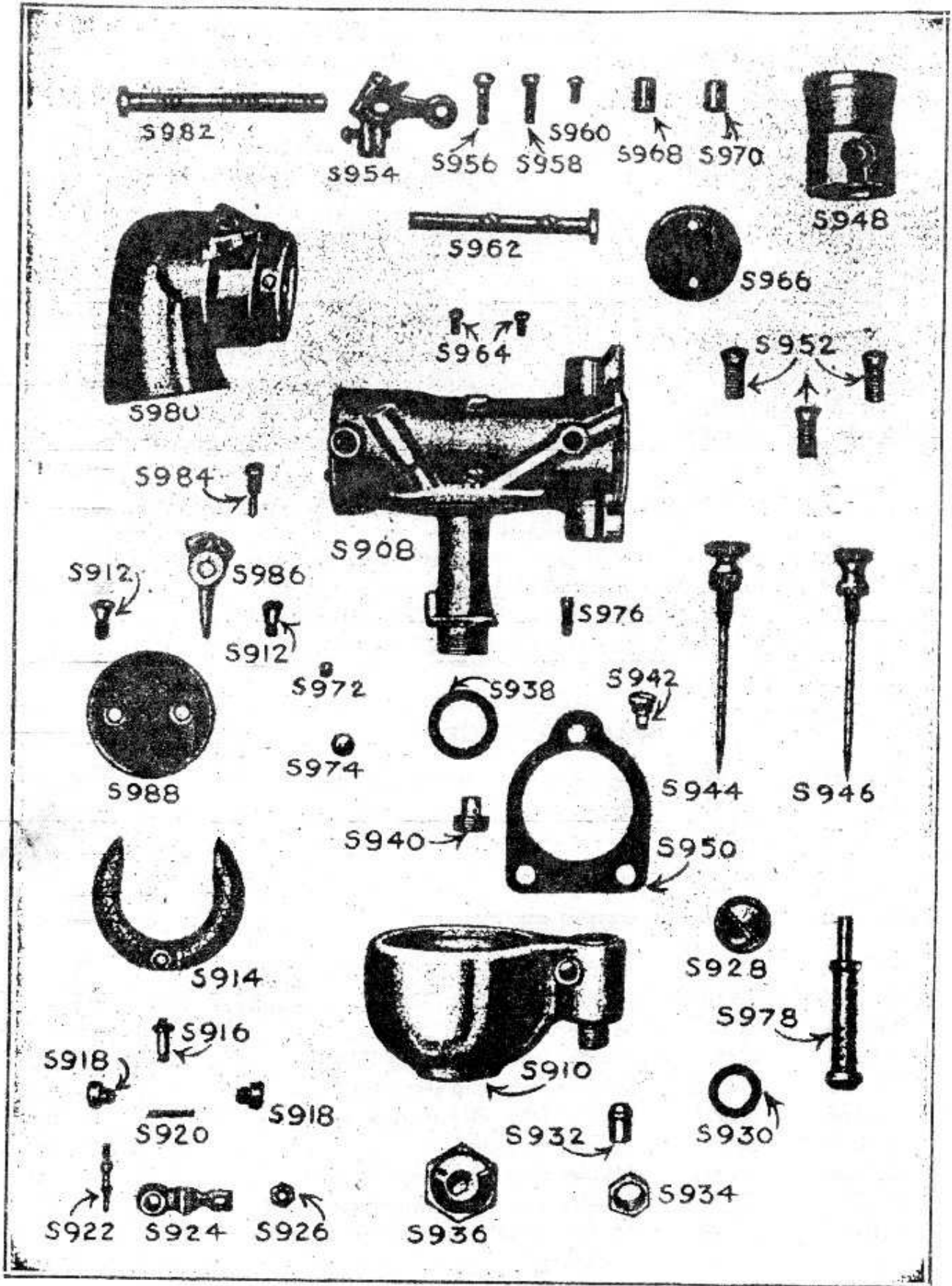

De Luxe Carburetor 1920-1927

EBLER DE LUXE CARBURETOR—(See Note)

Code	Factory No.	Part No.	DESCRIPTION	No. Used	Price Each
Bolly	23Q370X1	S900X1	DeLuxe Carburetor complete with manifold, cones and nuts		\$15.00
Bognu	23Q370X	S900X	Carburetor complete less manifold		13.50
Bogsi		S902X	Body complete		11.00
Ajeup		S904X	Bowl complete		5.00
Akope		S906X	Air intake complete		3.00
Bokwi		S908	Body casting		7.50
Alsti		S910	Bowl casting		4.00
Apnax		S912	Air intake retainer screws		.10
Apniq		S914	Float complete with washer screw		.50
Apnoe		S916	Float washer and screw		.10
Arnqu		S918	Float lever screw bearings		.10
Arraq		S920	Float lever pin		.05
Arrox		S922	Float valve		.30
Arsep		S924	Float lever		.20
Arsvu		S926	Float valve retainer nut		.10
Artew		S928	Bowl cap complete with gasket		.20
Artlu		S930	Bowl cap gasket		.02
Bokzu		S932	Gasoline union nipple		.05
Asahq		S934	Gasoline union nut		.10
Asamu		S936	Bowl lock nut		.30
Avhoq		S938	Bowl gasket		.02
Avlaw		S940	Nozzle retainer screw		.15
Bolpi		S942	Idle plug		.15
Bomci		S944	Low speed needle valve		.80
Bomwu		S946	High speed needle valve		.50
Bonex		S948	Venturi		.80
Bonti		S950	Manifold gasket		.05
Bonyd		S952	Manifold cap screws		.10
Buhiq		S954	Throttle lever complete with screws		.60
Avsyd		S956	Throttle lever lock screw		.02
Avunj		S958	Throttle stop screw		.02
Avuti		S960	Throttle stop lock screw		.02
Avwyk		S962	Throttle shaft complete with screws		.30
Awago		S964	Throttle disc and air intake disc screws		.02
Buhly		S966	Throttle disc		.10
Awcye		S968	Monel bushing for throttle shaft lower		.25
Awjri		S970	Monel bushing for throttle shaft upper		.25
Awmky		S972	Air bleed drill plug		.02
Awmsh		S974	Air bleed dust cap		.02
Awold		S976	Idle passage plug		.02
Buhzi		S978	Main nozzle		.80
Aylgo		S980	Air intake casting		2.00
Ayltu		S982	Air intake disc shaft		.40
Ayoca		S984	Air intake lever lock screw		.05
Azfaw		S986	Air intake lever		.70
Azguy		S988	Air intake disc		.10

Note: When the De Luxe carburetor is used with the late 1926 Scout manifold, it will be advisable to chamfer out the manifold to match up with the carburetor outlet.

Order by Number.

Give Motor Number.

Use order blanks which will be furnished on application

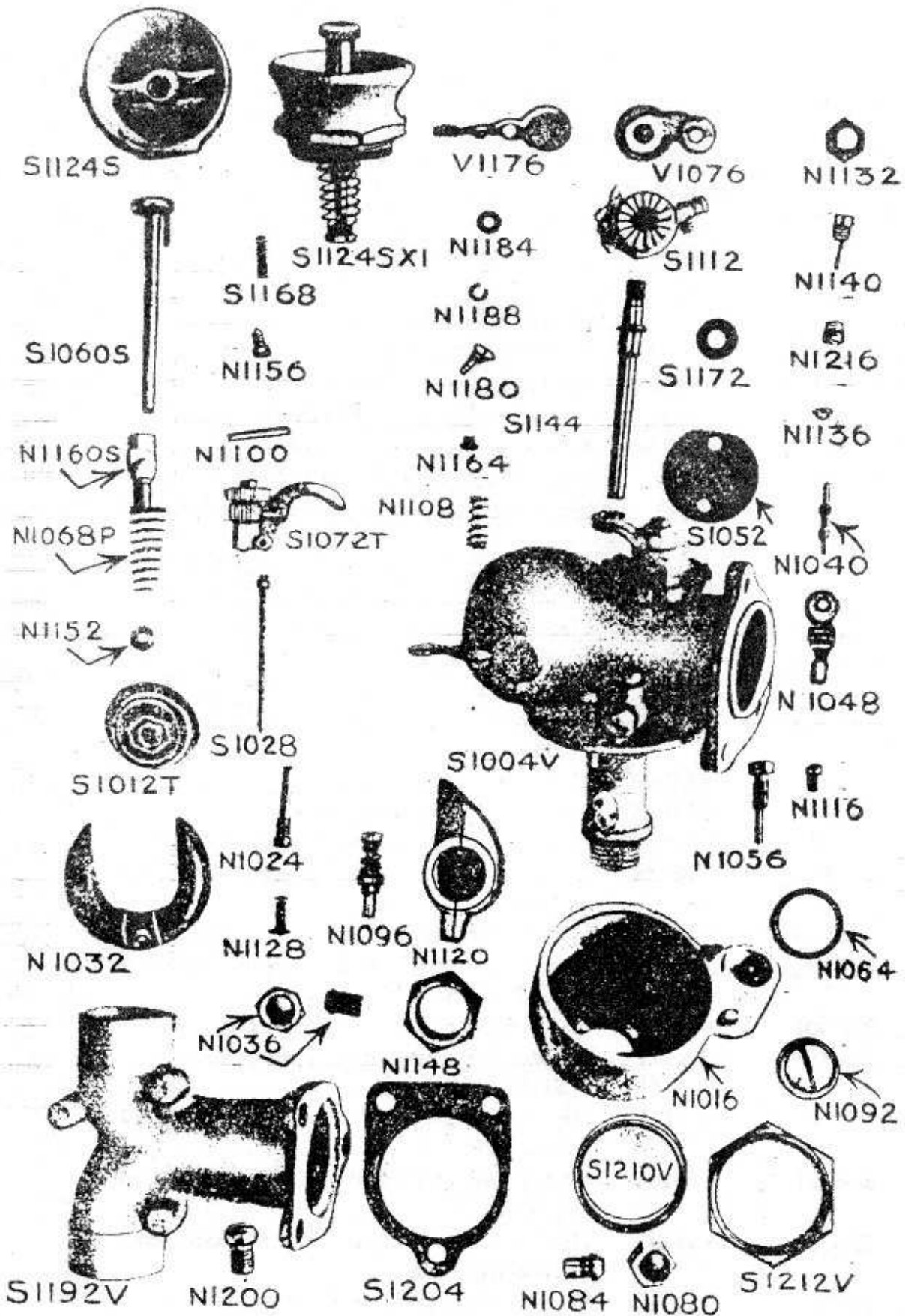

Model H Carburetor 1926

SCHEBLER CARBURETOR GROUP

Model H

Note: Early 1926 represents models from Motor No. AG100 to AG900
Late 1926 after AG900

Code	Factory No.	Part No.	DESCRIPTION	No. Used	Price Each
Altvu	20Q350X1	S1000X1	Carburetor complete with manifold, tubes and union nuts 1920-21-22	1	\$15.00
Altwi	24Q375X1	S1000SX1	Carburetor complete with manifold, tubes and union nuts, 1923-24-25 and early 1926	1	15.00
Buirt	26C13X1	S1000VX1	Carburetor complete with manifold, cones and nuts late 1926	1	15.00
Aludf	24Q375X	S1000TX	Carburetor complete less manifold 1920-21-22-23-24-25 and early 1926	1	13.50
Buisk		S1000VX	Carburetor complete less manifold late 1926	1	13.50
Alyoq		S1004	Body complete 1920-21-22-23	1	10.00
Alfyz		S1004T	Body complete 1924-25 and early 1926	1	10.00
Bujex		S1004V	Body complete late 1926	1	10.00
Algiq		S1008T	Bowl complete	1	5.00
Amcuq		S1012	Leather air valve disc 1920-21-22-23	1	.40
Alhew		S1012T	Leather air valve disc 1924-25-26	1	.40
Amewj	B	N1016	Bowl casting	1	4.00
Amidy		S1020	Body casting 1920-21-22-23	1	6.00
Bujlu		S1020T	Body casting 1924-25 and early 1926	1	6.00
Bujpi		S1020V	Body casting late 1926	1	6.00
Amiza	D	N1024	Spray nozzle	1	.15
Amrej		S1028	Needle valve 1920-21-22-23 and late 1926	1	.20
Bujty		S1028T	Needle valve 1924-25 and early 1926	1	.20
Amtaw	F	N1032	Cork float	1	.50
Amtru	G	N1036	Gasoline union parts R & S	1	.20
Amudo	H	N1040	Float valve	1	.30
Amvia	I	N1044	Needle valve adjusting knurl	1	.20
Amweh	J	N1048	Float lever	1	.20
Amwul		S1052	Throttle disc 1920-21-22-23 and late 1926	1	.05
Alihm		S1052T	Throttle disc 1924-25 and early 1926	1	.05
Amyst	LM	N1056	Low speed adjusting screw	1	.10
Anelq		S1060	Air valve starting stem complete 1920-21-22-23	1	.50
Alimd		S1060S	Air valve starting stem 1924-25-26	1	.50
Anifu	N	N1064	Cork gasket for bowl	1	.02
Anjdi	O	N1068	Air valve spring 1920-21-22-23	1	.05
Anjsu		N1068P	Air valve spring 1924-25-26	1	.05
Ankvu		S1072	Needle valve lift lever with roller 1920-21-22-23 and late 1926	1	.60
Aljaw		S1072T	Needle valve lift lever 1924-25 and early 1926	1	.60
Annca	Q	N1076	Throttle lever 1920-21-22-23-24-25 and early 1926	1	.30
Acbru		V1076	Throttle lever late 1926	1	.30
Annzi	R	N1080	Gasoline union nut	1	.10
Anpyf	S	N1084	Gasoline union nipple	1	.05

Order by Number.

Give Motor Number.

Use order blanks which will be furnished on application

Code	Factory No.	Part No.	DESCRIPTION	No. Used	Price Each
Ansri	T	N1088	Needle valve spring	1	\$.05
Anucu	U	N1092	Bowl cap	1	.20
Anvlyt	V	N1096	Flusher	1	.30
Apanx	W	N1100	Needle valve lift lever pin	1	.02
Apate		S1104	Needle valve guide 1920-21-22-23-26	1	.20
Aljeq		S1104T	Needle valve guide 1924-25	1	.20
Apeta	Y	N1108	Needle valve lift lever spring	1	.05
Apheq		S1112	Cam complete	1	1.00
Apito	1	N1116	Low speed lock screw	1	.02
Apnep	2	N1120	Air bend regular style 1920-21-22-23-24-25 and early 1926	1	.50
Aponq		S1124	Air valve casting 1920-21-22-23	1	1.50
Calox		S1124X1	Air valve casting complete 1920-21-22-23	1	2.25
Aljli		S1124S	Air valve casting 1924-25-26	1	1.50
Cameq		S1124SX1	Air Valve casting complete 1924-25-26	1	2.25
Aprey	4	N1128	Float washer and screw	1	.10
Apsky	5	N1132	Throttle lever lock nut	1	.02
Apumu	6	N1136	Float valve retainer nut	1	.10
Apvyd	7	N1140	Float lever screw	1	.10
Apynu		S1144	Throttle shaft 1920-21-22-23 and late 1926	1	.30
Aljru		S1144T	Throttle shaft 1924-25 and early 1926	1	.45
Arami	9	N1148	Bowl lock nut	1	.10
Arcaw	10	N1152	Air valve spring retainer nut	1	.05
Arcmu	11	N1156	Needle valve lock screw	1	.05
Ardwu	12	N1160	Air valve adjusting screw 1920-21-22-23	1	.20
Alkmu		N1160S	Air valve adjusting screw 1924-25-26	1	.20
Arekx	13	N1164	Lift lever pin lock screw	1	.02
Aresb		S1168	Friction spring	1	.05
Arinb		S1172	Throttle disc friction washer 1920-21-22-23 and late 1926	1	.02
Alkzi		S1172T	Throttle disc friction washer 1924-25 and early 1926	1	.02
Armki		S1176	High speed auxiliary air valve 1920-21-22-23	1	.10
Aroci	16	N1176	High speed auxiliary air valve 1924-25 and early 1926	1	.10
Aceap		V1176	High speed auxiliary air valve late 1926	1	.10
Arrem	17	N1180	Pivot screw for high speed auxiliary air valve	1	.10
Arsan	18	N1184	Washer for pivot screw	1	.02
Artax	19	N1188	Lock washer for pivot screw	1	.02
Arugi	20C13	S1192	Manifold 1920-21-22	1	1.75
Arult	23C2	S1192S	Carburetor manifold 1923	1	1.75
Alldy	24C11	S1192T	Manifold 1924-25 and early 1926	1	1.75
Bujyc	26C13	S1192V	Carburetor manifold late 1926	1	1.50
Bulow	26C13X	S1192VX	Carburetor manifold complete with cones and nuts late 1926	1	2.00
Asaki	21	N1196	Manifold tube clamping screw 1920-21-22-23-24-25 and early 1926	2	.03
Asbaw	22	N1200	Manifold and body screw	3	.10
Asgew		S1204	Manifold gasket	1	.05

Order by Number.

Give Motor Number.

Use order blanks which will be furnished on application

Code	Factory No.	Part No.	DESCRIPTION	No. Used	Price Each
Asiju	20B11	S1208	Manifold tubes 1920-21-22-23-24-25 and early 1926	2	\$.15
Bulun	26B22	S1210V	Manifold cone late 1926	2	.15
Asphy	20B125	S1212	Manifold tube nuts 1920-21-22-23-24-25 and early 1926	2	.25
Bumis	26B23	S1212V	Manifold union nut late 1926	2	.25
Aswoq	26	N1216	Float lever pin bearing	1	.10
Aloju		N1218	Monel bushing for body	1	.20
Ataxo	27	N1220	Needle valve lift lever roller and pin	1	.10
Azlax		T1224	Lift lever fibre	1	.02
Axlyf		T1226	Adjusting screw for cam track	1	.10
Azoka		T1228	Lock screw for cam track screw	1	.02

PRIMER GROUP

Atezi	H13501X	N1304X	Primer cup 1920-21-22	2	\$.80
Atinz	24B76X	N1300KX	Primer complete 1923-24-25-26	2	.40
Atkru	C13550	N1324	Primer cup gasket 1920-21-22	2	.02
Atmoq	18A123	N1324K	Primer gasket 1923-24-25-26	2	.01
Atoal	20B406	S1328	Primer cup cylinder plug 1920-21-22	2	.20
Bumfi	23B150	S1332	Primer cup cylinder plug gasket 1920-21-22	2	.05

HANDLE BAR AND GRIP CONTROL GROUP

Attsi	26E25X1	S1350X1	Handle bar and controls assembly	1	\$20.00
Avbly	20E42X	S1354	Handle bar top assembly 1920-21-22	1	14.00
Avbow	26E25X	S1354S	Handle bar top assembly 1923-24-25-26	1	14.00
Avegu	20B665S	N6815Q	Handle bar top bracket and fork side clamping screw	2	.10
Aveto	20B385	N1392P	Handle bar grip	2	.30
Avgeq	23B7	N1394S	Handle bar grip extension	2	.08
Avhek	20B390	N1398P	Handle bar grip extension sleeve 1920-21-22	2	.10
Avhil	23B8	N1398S	Handle bar grip extension sleeve 1923-24-25-26	2	.10
Avhum	20B386X	N1402PX	Handle bar grip control sleeve 1920-21-22	2	1.50
Aviki	23B9X	N1402SX	Handle bar grip control sleeve assembled 1923-24-25-26	2	1.50
Avlej	20B391	N1406P	Handle bar grip control sleeve pin	6	.02
Avmew	20B388	N1411P	Handle bar grip control sleeve block 1920-21-22	2	.10
Avmin	23B10	N1411S	Handle bar grip control sleeve block 1923-24-25-26	1	.10
Avnec	20B387	N1410P	Handle bar grip control sleeve block screw 1920-21-22	2	.02
Avols	23B11	N1410S	Handle bar grip control sleeve block screw 1923-24-25-26	2	.02
Avorq	18A23	N1414K	Handle bar grip control spiral	2	.70
Avori	18A24X	N810KX	Handle bar grip control spiral block	2	.40
Avtap	18A71	N1417K	Handle bar grip control spiral block pin	4	.02
Avuza	18A72	N814K	Handle bar grip control spiral block and control wire binding screw	2	.02

Order by Number.

Give Motor Number.

Use order blanks which will be furnished on application

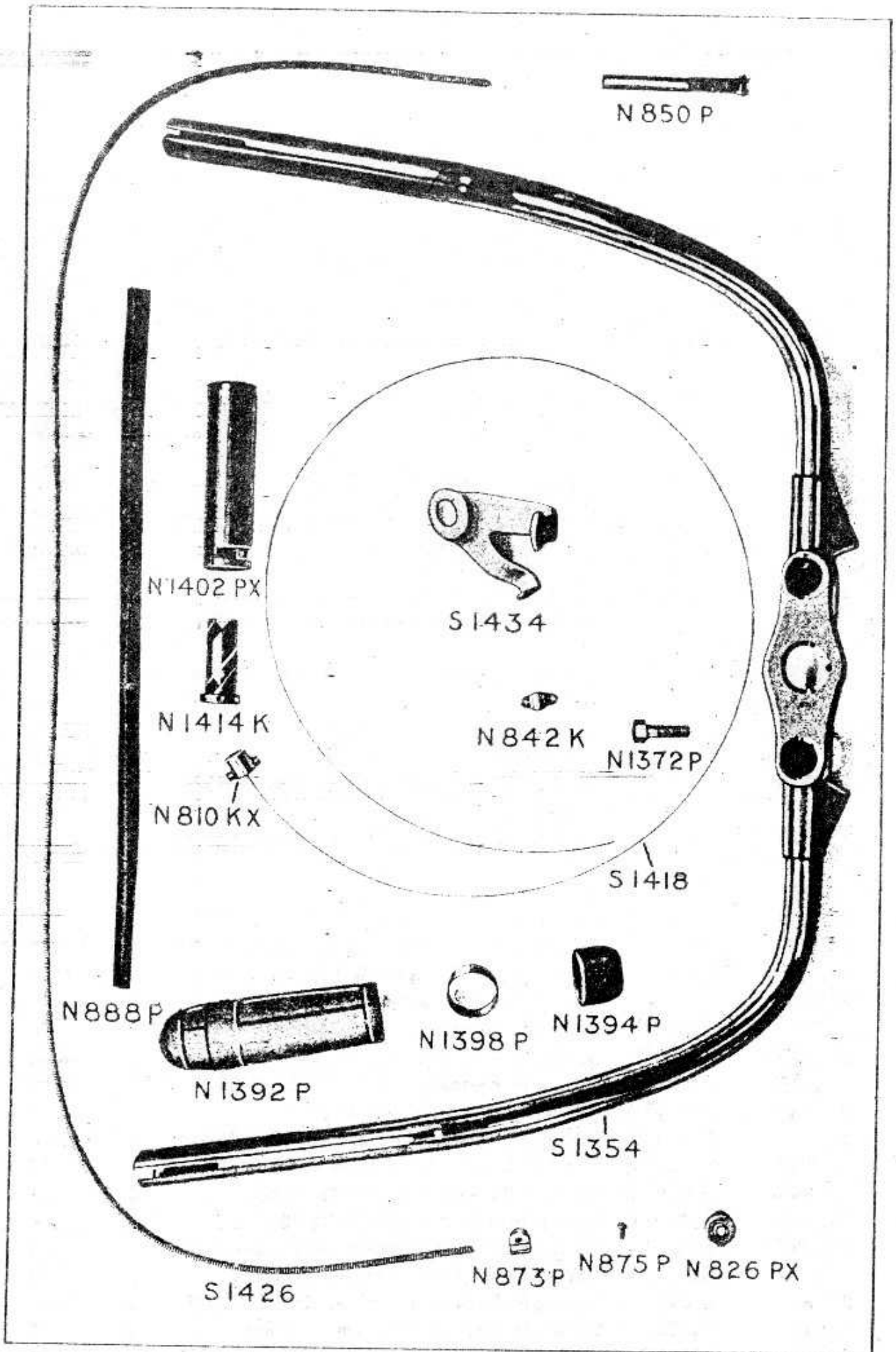

Handle Bar and Grip Control Group 1920-1924

Code	Factory No.	Part No.	DESCRIPTION	No. Used	Price Each
Awapx	20B40	S1418	Handle bar grip control magneto wire 51" long 1920-21-22	1	\$.15
Awint	20B394	S1422	Handle bar grip control magneto wire 52" long 1923	1	.15
Awirx	22B639	S1422S	Handle bar grip control magneto wire 53" long 1924-25-26	1	.15
Awint	20B394	S1422	Handle bar grip control carburetor wire 52" long 1920-21-22	1	.15
Awirx	22B639	S1422S	Handle bar grip control carburetor wire 53" long 1923-26	1	.15
Awequ	23B93	T1418S	Handle bar grip control carburetor wire 54" long 1924-25	1	.15
Awjly	20B404	N850P	Handle bar grip control carburetor and magneto clevis 1920-21 (also magneto clevis 1922)	2	.50
Awibu	22B509	S1423R	Handle bar grip control carburetor clevis 1922	1	.40
Awlly	23B76X	N850SX	Handle bar grip control wire casing sleeve 1923-24-25-26	2	.25
Awleq	A26190	N2294	Handle bar grip control carburetor and magneto clevis pin 1920-21-22	2	.05
Awlvi	23B77	N854S	Handle bar grip control wire casing sleeve stud 1923-24-25-26	2	.10
Akazi	A3230	N614	Handle bar grip control carburetor and magneto clevis pin cotter pin 1920-21-22	2	.01
Awmdi	C1372	S2491	Handle bar grip control wire casing sleeve stud cotter pin 1923-24-25-26	2	.01
Awmtu	D34370	N862K	Handle bar grip control carburetor and magneto clevis binding screw	2	.01
Awoms	20B403	S1426	Handle bar grip control magneto wire casing 47" long 1920-21-22	1	.50
Awsbi	23B87	S1426S	Handle bar grip control magneto wire casing 47 1/4" 1923	1	.50
Awsdu	22B640	S1426T	Handle bar grip control magneto wire casing 49" long 1924-25-26	1	.50
Awtnu	20B395	S1430	Handle bar grip control carburetor wire casing 48" long 1920-21-22	1	.50
Awtyc	23B88	S1430S	Handle bar grip control carburetor wire casing 48 1/4" 1923	1	.50
Awuqa	24B41	S1430T	Handle bar grip control carburetor wire casing 50" long 1924-25	1	.50
Awsdu	22B640	S1426T	Handle bar grip control carburetor wire casing 49" long 1926	1	.50
Awuzi	20B405	N873P	Handle bar grip control wire casing stop clip	2	.05
Awczu	A6230	N875P	Handle bar grip control wire casing stop clip screw	2	.01
Awzyf	A6210	N1298	Handle bar grip control wire casing stop clip screw nut	2	.02

Order by Number.

Give Motor Number.

Use order blanks which will be furnished on application

Code	Factory No.	No.	DESCRIPTION	No. Used	Price Each
Axtwu	19B111S	N863K	Handle bar grip control wire casing stop clip screw nut lock washer	2	\$.01
Ayafa	20B400	N888P	Handle bar grip control wire casing cover	2	.40
Ayfew	18A88	N874K	Handle bar grip control wire casing frame clip 1920-21-22	2	.03
Algia	D24305	N1634	Handle bar grip control wire casing frame clip screw 1920-21-22	2	.03
Akosh	19B112S	N2808	Handle bar grip control wire casing frame clip screw lock washer 1920-21-22	2	.01
Ayohi	24B25	S1431T	Handle bar grip control wire casing upper stop	2	.05
Aypzi	18A37	N830K	Handle bar grip control wire casing upper stop pin	4	.03
Ayule	20C90	S1434	Handle bar grip control wire casing lower bracket 1920-21-22-23-24	1	.35
Ayumo	24B44	S1434T	Handle bar grip control wire casing tank bracket 1924-25-26	1	.10
Aksoq	23B150	S1332	Handle bar grip control wire casing lower bracket gasket 1920-21-22-23-24	1	.05
Azeba	18A74	N842K	Handle bar grip control wire casing lower bracket clip 1920-21-22-23-24	2	.05
Azede	24B45	S1435T	Handle bar grip control wire casing tank bracket clip 1924-25-26	1	.02
Azeko	B8257	N846P	Handle bar grip control wire casing lower bracket clip screw 1920-21-22-23-24	4	.01
Laided	D10470	N4080	Handle bar grip control wire casing tank bracket clip screw 1924-25-26	1	.03
Deared	A14140	N1408	Handle bar grip control wire casing tank bracket clip screw nut 1924-25-26	1	.01
Husked	19B112S	N2808	Handle bar grip control wire casing tank bracket clip screw nut lock washer 1924-25-26	1	.01
Alosq	24B115	S1438T	Handle bar grip control carburetor wire casing clip 1925-26	1	.05
Alots	24B116	S1440T	Handle bar grip control magneto wire casing clip 1925-26	1	.05
Alpki	A10470	N4026	Handle bar grip control magneto wire casing clip screw 1925-26	1	.03
Adest	A1210	N202	Handle bar grip control magneto wire casing clip screw nut 1925-26	1	.03
Azfyc	18A26	N882K	Handle bar grip control magneto advance lever swivel 1920-21	1	.15
Azimj	A29350	N886K	Handle bar grip control magneto advance lever swivel washer 1920-21	1	.02

HEAD FITTING GROUP

Azjye	20B260	S1500	Head upper cup	1	\$.60
Azlew	20B261	S1504	Head lower cup	1	.60
Azuwi	20B263	S1508	Head adjusting cone	1	.80
Baasq	17B3	N1512	Head adjusting cone nut	1	.70

Order by Number.

Give Motor Number.

Use order blanks which will be furnished on application

Code	Factor No	Part No.	DESCRIPTION	No. Used	Price Each
Baciq	18A22	N1514M	Head adjusting cone nut lock washer.	1	\$.03
Badeq	20B262	S1516	Head lower fork $\frac{1}{2}$ "	1	.50
Baest	C18120	N1520	Head bearing ball $\frac{1}{4}$ "	42	.01

SPRING FORK GROUP

Baidy	20E30X	S1550X	Spring fork assembly complete 1920-21-22-23	1	\$32.50
Baile	25D26X	S1550TX	Spring fork assembly complete 1924-25-26	1	32.50
Bakot	20E11X1	S1554X	Spring fork main frame with cone 1920-21-22-23	1	18.00
Balfi	24C31X1	S1554TX	Spring fork main frame 1924 and early 1925	1	18.00
Averi	25C66X	S1554UX	Spring fork main frame late 1925 and 1926	1	18.00
Bamki	18B1	N1558K	Spring fork stem	1	1.25
Bania	18A15	N1562K	Spring fork stem 1st. reinforcement	1	.60
Baomi	17A73	N1566	Spring fork stem 2nd reinforcement	1	.30
Barfu	18D1	N1570K	Spring fork stem crown 1920-21-22-23	1	2.25
Bargi	24D26	S1570T	Spring fork crown 1924-25-26	1	2.25
Bastu	20D15	S1578	Spring fork side right 1920-21-22-23	1	2.25
Basym	24D29	S1578T	Spring fork side right 1924-25-26	1	2.25
Bauby	20D14	S1582	Spring fork side left 1920-21-22-23	1	2.25
Baunj	24D30	S1582T	Spring fork side left 1924-25-26	1	2.25
Bayrk	20B176	S1584	Spring fork side reinforcement 1920-21-22-23	2	.10
Baypi	20B755	S1581T	Spring fork side lower end reinforcement 1924	2	.10
Alpsu	24B177	S1581U	Spring fork side lower end reinforcement 1925-26	4	.10
Baysh	22B338	S1584T	Spring fork side inside reinforcement 1924-25-26	2	.25
Bayrk	20B176	S1584	Spring fork side outside reinforcement 1924-25-26	2	.10
Beafy	20B177	S1583	Spring fork side end cap	2	.10
Ahana	16A396	S396	Spring fork side end cap rivet	2	.01
Becri	20D17	S1586	Spring fork truss right 1920-21-22-23	1	.75
Becyd	24D27	S1586T	Spring fork truss right 1924-25-26	1	.75
Beeta	20D16	S1590	Spring fork truss left 1920-21-22-23	1	.75
Beezi	24D28	S1590T	Spring fork truss left 1924-25-26	1	.75
Begib	20C33X	S1620X	Spring fork spring assembly 1920-21-22-23	1	4.00
Beglu	24C24X	S1620TX	Spring fork spring assembly 1924-25-26	1	4.00
Aluvi	24C24A	S1620TA	Spring fork top leaf 1924-25-26	1	.75
Alwuq	24C24B	S1620TB	Spring fork second or main leaf 1924-25-26	1	1.00
Alyng	24C24C	S1620TC	Spring fork third leaf 1924-25-26	1	.75
Alzpi	24C24D	S1620TD	Spring fork fourth leaf 1924-25-26	1	.65
Amane	24C24E	S1620TE	Spring fork fifth leaf 1924-25-26	1	.60
Amatx	24C24F	S1620TF	Spring fork sixth or bottom leaf 1924-25-26	1	.55
Camgu	24B179	S1621T	Spring fork spring rivet 1924-25-26	1	.02
Belux	20C34	S1622	Spring fork spring main leaf 1920-21-22-23	1	1.00
Benav	20B169	S1625	Spring fork spring main leaf bushing	1	.20
Beoge	24B96	S1628T	Spring fork spring oil hole cover 1924-25-26	1	.02

Order by Number.

Give Motor Number.

Use order blanks which will be furnished on application

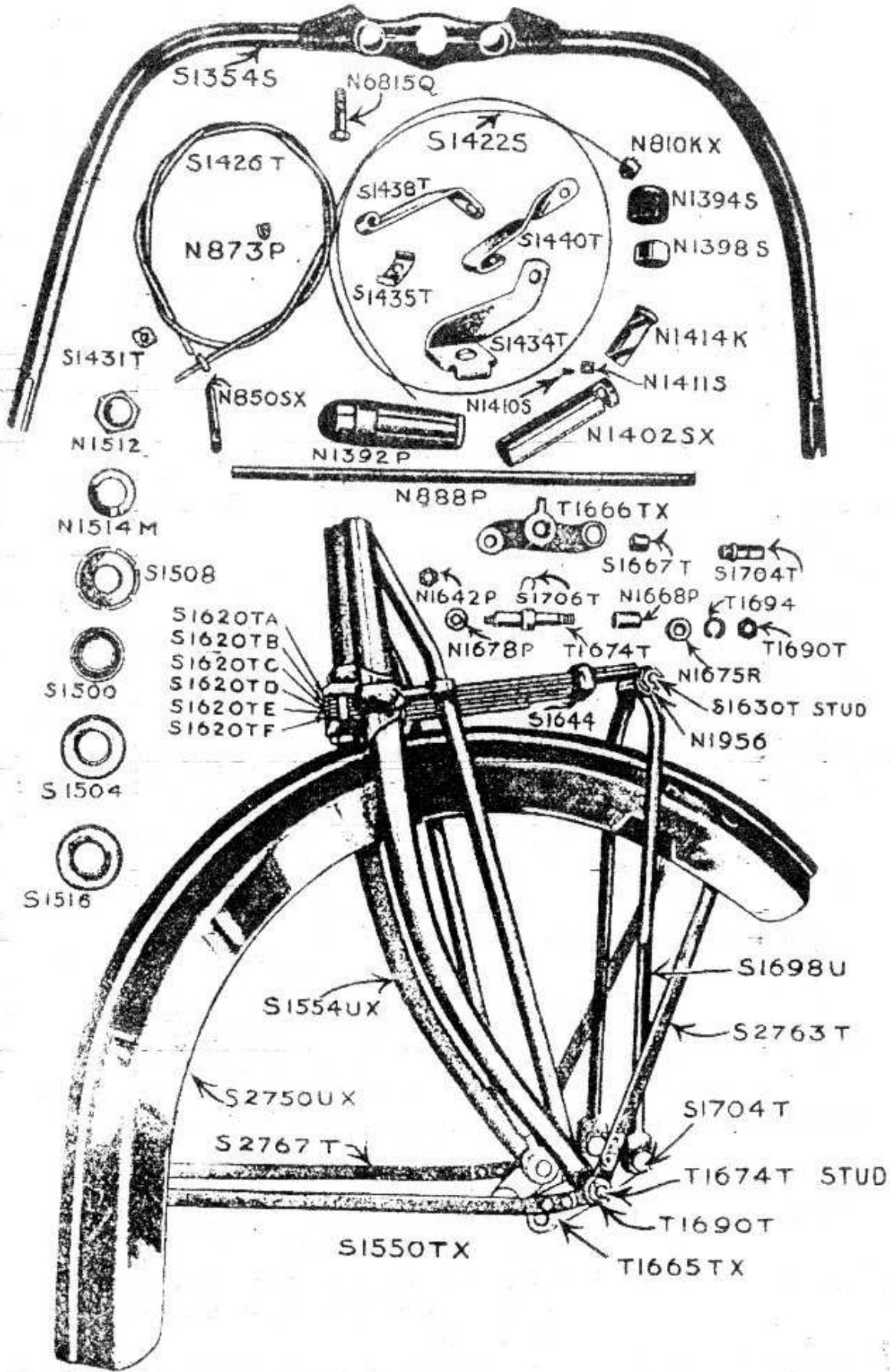

Handle Bar—Front Fork Groups 1926

Code	Factor No.	Part No.	DESCRIPTION	No. Used	Price Each
Beopo	E1647	N1630	Spring fork spring main leaf stud 1920-21-22-23	1	\$.40
Beoti	24B82	S1630T	Spring fork spring and connecting link stud 1924-25-26	1	.40
Algia	D24305	N1634	Spring fork spring main leaf stud oil hole screw 1920-21-22-23	1	.03
Beswu	18A136	N1635	Spring fork spring main leaf stud oil hole screw washer 1920-21-22-23	1	.01
Betku	A19040	N1638	Spring fork spring main leaf oil hole screw leather washer 1920-21-22-23	1	.01
Bewip	F1320	N1956	Spring fork spring main leaf stud nut	2	.05
Beyst	E16485	N1646	Spring fork spring main leaf stud nut lock ring	1	.01
Bezwi	20C35	S1628	Spring fork spring 2nd leaf 1920-21-22-23	1	.75
Biaka	20B172	S1632	Spring fork spring 3rd leaf 1920-21-22-23	1	.65
Bidax	20B173	S1636	Spring fork spring 4th leaf 1920-21-22-23	1	.55
Bidyd	20B174	S1640	Spring fork spring 5th leaf 1920-21-22-23	1	.60
Bieji	20B170	S1644	Spring fork spring clip	1	.10
Bifdy	20B171	S1648	Spring fork spring clip and leaf rivet	1	.01
Bifni	20B315	S1653	Spring fork spring clip rivet	1	.02
Bijeg	18A18	N1654K	Spring fork spring plate 1920-21-22-23	1	.20
Bijyf	24B84	S1654T	Spring fork spring plate 1924-25-26	1	.20
Bikew	C16532	N1658	Spring fork spring plate and crown leather washer 1920-21-22-23	1	.05
Bilbu	20B237S	S1662	Spring fork spring bolt 1920-21-22-23	4	.10
Adicq	19B114S	N214	Spring fork spring bolt nut lock washer 1920-21-22-23	4	.01
Adfye	19A58	N211	Spring fork spring bolt nut 1920-21-22-23	4	.03
Bildi	24B88S	S1662T	Spring fork spring front bolt 1924-25-26	2	.20
Allumined	20B228S	N211P	Spring fork spring front bolt nut 1924-25-26	2	.03
Flaked	19B115S	N1960	Spring fork spring front bolt nut lock washer 1924-25-26	2	.01
Bisyc	24B89S	S1663T	Spring fork spring rear bolt 1924-25-26	2	.10
Adfye	19A58	N211	Spring fork spring rear bolt nut	2	.03
Adicq	19B114S	N214	Spring fork spring rear bolt nut lock washer	2	.01
Blado	20B253X	N1666PX	Spring fork bell crank assembly 1920-21-22-23	2	1.85
Bitsu	24B80X	S1665TX	Spring fork bell crank with bushing right, 1924 and early 1925	1	1.60
Bivgi	24B86X	T1665TX	Spring fork bell crank with bushing right, late 1925 and 1926	1	1.60
Blapa	24B81X	S1666TX	Spring fork bell crank with bushing left, 1924 and early 1925	1	1.60
Blare	24B87X	T1666TX	Spring fork bell crank with bushing left, late 1925 and 1926	1	1.60
Blati	20B161	N1667P	Spring fork bell crank connecting link pin hole bushing 1920-21-22-23	2	.25
Amdoq	24B150	S1667T	Spring fork bell crank connecting link pin hole bushing 1924-25-26	2	.30

Order by Number.

Give Motor Number.

Use order blanks which will be furnished on application

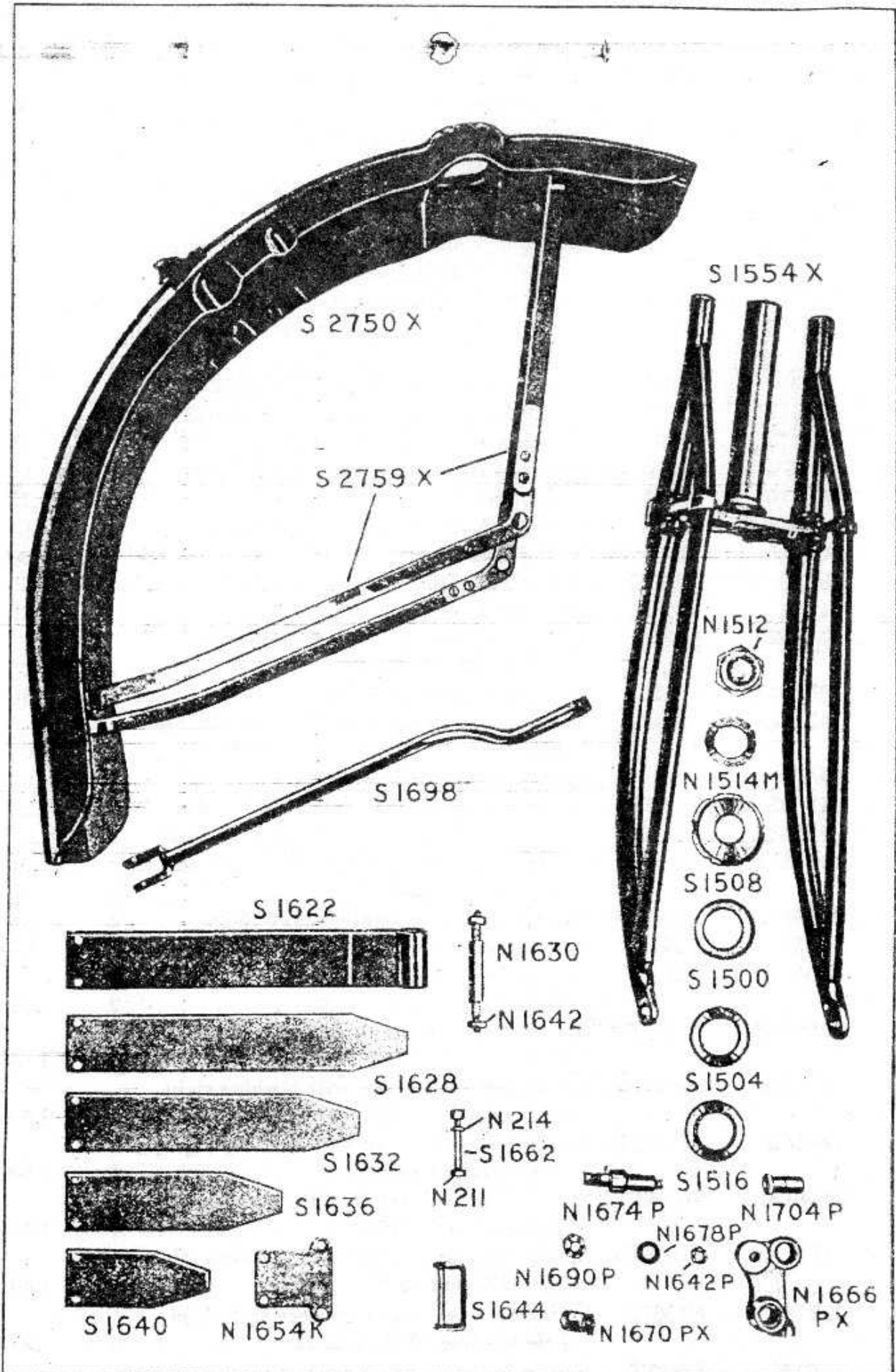

Fork Group Model G-20-21-22-23

Code	Factor No.	Part No.	DESCRIPTION	No. Used	Price Each
Bleka	20B16.	N1668P	Spring fork bell crank fork side stud hole bushing	2	\$.30
Blezy	20B266X	N1670PX	Spring fork bell crank grease cup 1920-21-22-23	2	.50
Bligo	20B267	N1671P	Spring fork bell crank grease cup lock wire 1920-21-22-23	2	.03
Detain	F16580X	H1669	Spring fork bell crank fork side stud oiler 1924-25-26	2	.15
Blobo	20B159	N1674P	Spring fork bell crank and fork side stud 1920-21-22-23	2	.50
Blowa	20B425	N4585P	Spring fork bell crank and fork side stud 1924-25	2	.50
Amead	25B307	T1674T	Spring fork bell crank and fork side stud late 1925 and 1926	2	.50
Blugu	22B177	N1675R	Spring fork bell crank and fork side stud mud guard brace spacing washer 1924-25-26	2	.06
Bluze	20B163	N1678P	Spring fork bell crank and fork side stud inside washer	2	.03
Boaja	20B164S	N1642P	Spring fork bell crank and fork side stud inside nut	2	.03
Bobow	B16481	N1679P	Spring fork bell crank and fork side stud inside nut cotter pin	2	.01
Boclu	20B165S	N1690P	Spring fork bell crank and fork side stud outside nut 1922-23-24 and early 1925	2	.10
Armlly	25B308	T1690T	Spring fork bell crank fork side stud outside nut late 1925 and 1926	2	.06
Aqduq	20B238S	N1694P	Spring fork bell crank and fork side stud outside nut cotter pin	2	.01
Bofax	20C31	S1698	Spring fork bell crank connecting link 1920-21-22-23	2	2.00
Bofej	24C28	S1698T	Spring fork bell crank and spring connecting link 1924 and early 1925	2	2.00
Awofa	25C96	S1698U	Spring fork bell crank and spring connecting link late 1925 and 1926	1	2.50
Bohcu	20B160	N1704P	Spring fork bell crank spring connecting link lower end pin 1920-21-22-23	2	.25
Bohni	24B94	S1704T	Spring fork bell crank spring connecting link lower end pin 1924-25-26	2	.50
Bojri	B16481	N1679P	Spring fork bell crank spring connecting link lower end pin cotter pin 1920-21-22-23	2	.01
Aqduq	20B238S	N1694P	Spring fork bell crank fork side stud outside nut cotter pin 1924-25-26	2	.01
Bojmu	24B95	S1706T	Spring fork bell crank and spring connecting link lower end pin oil hole cover 1924-25-26	2	.02
Uxdum	A29560	N5692	Spring fork bell crank spring connecting link lower end pin hole plug 1924-25-26	2	.01

Order by Number.

Give Motor Number.

Use order blanks which will be furnished on application

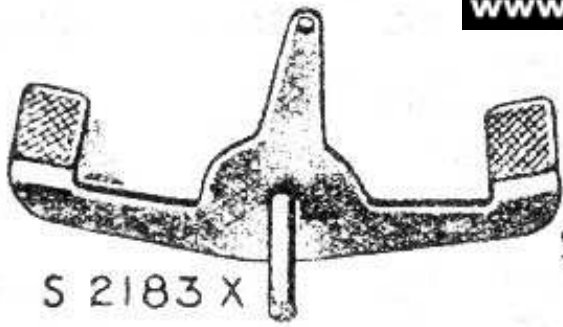

S 2183 X

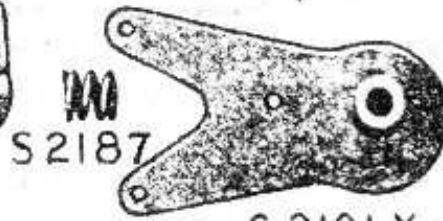

S 2187

S 2191 X



S 2195



N1690 P



S 2159



S 2163



S 2167



S 2155



S 2151



S 2107



S 2171

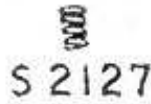

S 2127



S 2143



S 2147 X



S 2175

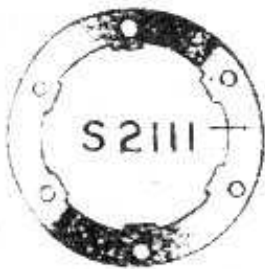

S 2111



S 2103

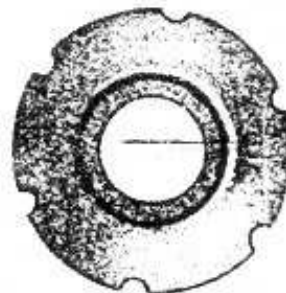

S 2139

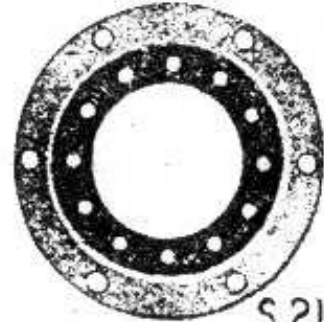

S 2135 X



S 2413



S 70



S 2405



S 2393 X



S 65



S 2423



S 2299 X

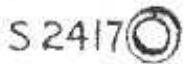

S 2417



S 81

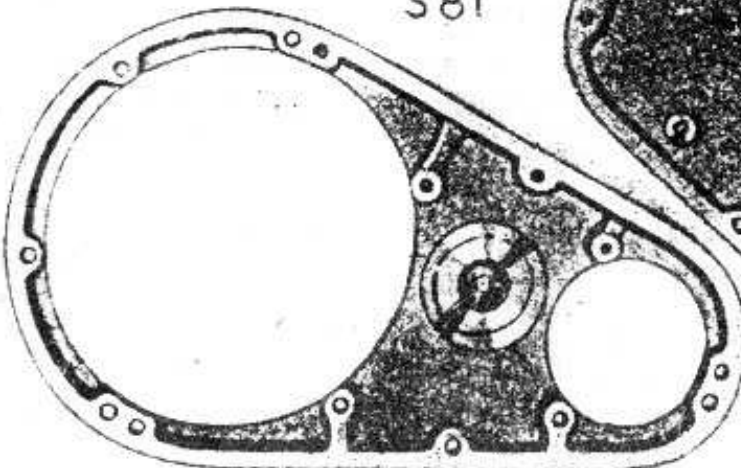

S 2433

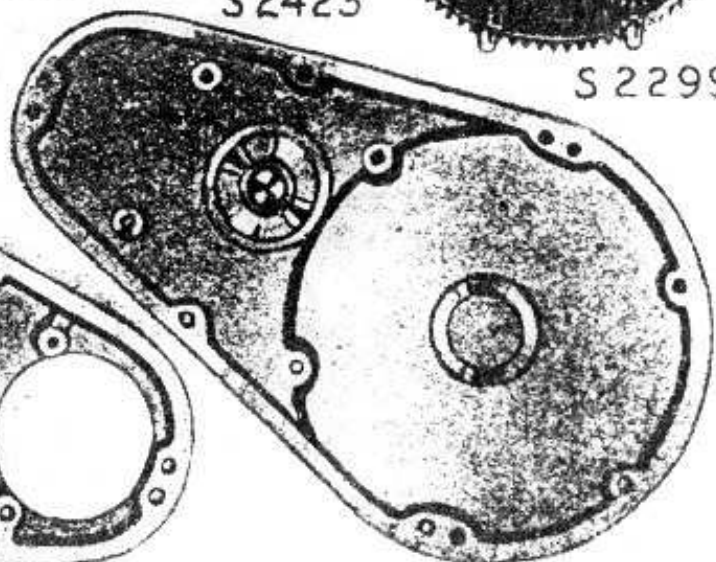

S 2437 X

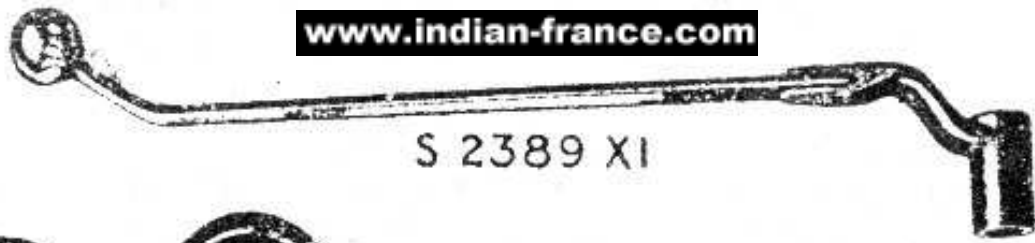

S 2389 XI



N 5080



S 2297



S 2215



S 2315



S 2219



S 2291



S 2295

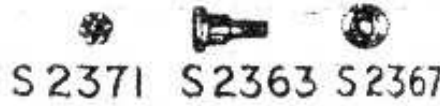

S 2371 S 2363 S 2367

S 2385



S 2359



N 5046 X



S 2311



S 2379



S 2387



S 2331

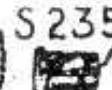

S 2351

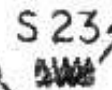

S 2347

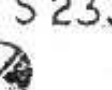

S 2335

S 2343

S 2355

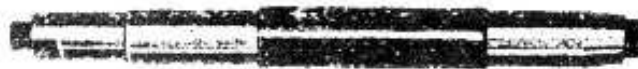

S 2251



S 2255



S 2271

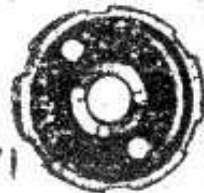

S 2263

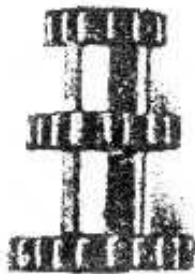

S 2319 X



S 2327



S 2279 X



N 5092

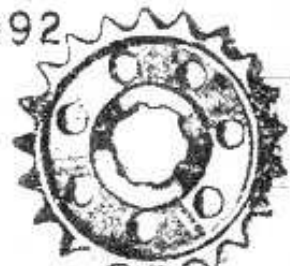

N 5088



S 2211

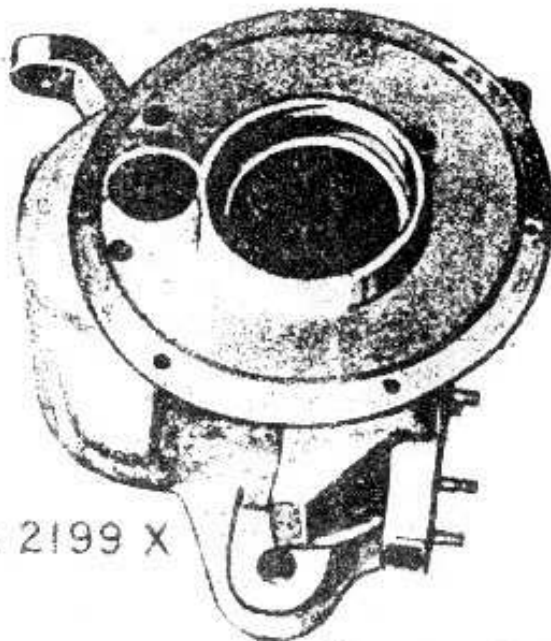

S 2199 X

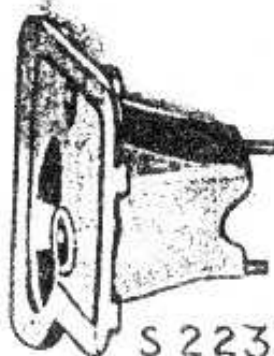

S 2231

S 2247



S 2243

Code	Factory No.	Part No.	DESCRIPTION	No. Used	Price Each
Bynuz	20E7X	S1750X	Frame assembly 1920-21	1	\$45.00
Byblu	23E14X	S1750RX	Frame assembly 1922-23	1	45.00
Bysaq	24E4X	S1750TX	Frame assembly 1924	1	45.00
Ameyb	26E31X	S1750UX	Frame assembly 1925-26	1	45.00
Byunk	22Q818	S1752	Frame head transfer	1	.05
CLUTCH AND TRANSMISSION GROUP					
Caape	20E6X	S2100X	Clutch and transmission assembly 1920-21	1	\$80.00
Caluq	26E32X	S2100RX	Clutch and transmission assembly 1922-23-24-25-26	1	80.00
Canax	20B58	S2103	Clutch outer driver plate 1920-21-22-23-24	1	.50
Caofi	20B928	S2105	Clutch raybestos plate 1920-21-22-23-24	4	.30
Amhax	25B93	S2105U	Clutch raybestos driver plate 1925-26	5	.30
Carej	20B59	S2107	Clutch driver plate 1920-21-22-23-24	2	.50
Cathi	20B60	S2111	Clutch driven plate 1920-21-22-23-24	3	.50
Cathi	20B60	S2111	Clutch driven plate 1925-26	5	.50
Cawun	20B55	S2115	Clutch plate stud	6	.10
Ceblu	A16260	S2119	Clutch plate stud nut	6	.03
Ceciq	20B56	S2123	Clutch plate stud nut lock washer	6	.01
Cedew	20B1011	S2127	Clutch tension spring	8	.03
Cefzu	20B54	S2131	Clutch tension spring stud	12	.03
Cehyd	20B121X	S2135X	Clutch tension spring plate assembly	1	.75
Ceism	20B57	S2139	Clutch release plate	1	.40
Celfy	20B52	S2143	Clutch release thrust bearing ball race 1920-21-22-23	2	.40
Celim	24B38	S2143T	Clutch release thrust bearing ball race 1924-25-26	2	.50
Bafuz	C18120	N1520	Clutch release thrust bearing ball 1920-21-22-23	16	.01
Cenvi	20B51X	S2147X	Clutch release thrust bearing ball retainer with balls 1920-21-22-23	1	.50
Amihf	24B40	S2147TX	Clutch release thrust bearing ball retainer with balls 1924-25-26	1	.40
Cenwo	23B72	S2151	Clutch release worm 1920-21-22-23	1	1.75
Ceota	24B48	S2151T	Clutch release worm 1924-25-26	1	1.75
Cepeq	23B73	S2155	Clutch release worm nut	1	.75
Cepuy	20B50	S2159	Clutch release worm nut dust cap	1	.15
Cermi	20B294	S2163	Clutch release worm nut dust cap packing	1	.02
Cetju	20B293	S2167	Clutch release worm collar 1920-21-22-23	1	.08
Cevsu	24B49	S2167T	Clutch release worm collar 1924-25-26	1	.25
Chacu	20B61	S2171	Clutch release worm lever 1920-21-22	1	.60
Chadi	23B80	S2171S	Clutch release worm lever 1923-24-25-26	1	.60
Chako	23B70	S2172S	Clutch release worm lever swivel 1923-24-25-26	1	.10
Chebi	D24275	N4296	Clutch release worm lever swivel washer 1923-24-25-26	1	.01
Checa	A2140	S2173	Clutch release worm lever swivel cotter pin 1923-24-25-26	1	.01
Chale	20B295	S2175	Clutch release worm lever nut	1	.05

Order by Number.

Give Motor Number.

Use order blanks which will be furnished on application

Code	Factor No	Part No.	DESCRIPTION	No. Used	Price Each
Chedo	19B	S2177	Clutch release worm lever nut lock washer	1	\$.01
Chibu	20B319	S2179	Clutch release rod 1920-21	1	.20
Chizi	22B502	S2179R	Clutch release rod 1922	1	.20
Chobo	23B75	S2179S	Clutch release rod 1923-24-25-26	1	.20
Chude	20B957	S2181	Clutch release rod clevis (rear) 1920-21	1	.45
Chula	22B449	S2181R	Clutch release rod clevis (rear) 1922	1	.45
Chusf	D26920	N4274	Clutch release rod clevis (front) 1920-21	1	.35
Chyen	19A45	N4274M	Clutch release rod clevis (front) 1922	1	.50
Akdax	A22210	N2758	Clutch release rod clevis nut 1920-21	2	.03
Chyrk	19A37	N4278M	Clutch release rod clevis nut 1922	2	.03
Ciack	C26925	N4282	Clutch release rod clevis pin 1920-21-22	2	.05
Chebi	D24275	N4296	Clutch release rod washer 1923-24-25	1	.01
Ciamt	B16480	N4132	Clutch release rod clevis pin cotter pin 1920-21-22	2	.01
Checa	A2140	S2173	Clutch release rod cotter pin 1923-24-25-26	2	.01
Ciasb	20B316X	S2183X	Clutch release foot lever assembly 1920-21- 22	1	1.25
Ciavd	24C23X1	S2183SX	Clutch release foot lever assembly 1923- 24-25	1	1.25
Bumvu	26C32X1	S2183VX	Clutch release foot lever assembly 1926	1	1.25
Cibaj	24C23X2	T2183X1	Clutch release foot lever complete with bracket 1923-24-25	1	2.25
Bumyd	26C39X	S2183VX1	Clutch release foot lever complete with bracket 1926	1	2.25
Afaka	20B311	V2360	Clutch release foot lever shaft	1	.25
Boclu	20B165S	N1690P	Clutch release foot lever shaft nut	1	.10
Agduq	20B238S	N1694P	Clutch release foot lever shaft nut cotter pin	1	.01
Cicel	20B966S	S2185	Clutch release foot lever shaft bearing oiler	1	.10
Cicno	20B313	S2187	Clutch release foot lever tension spring	1	.05
Cidal	24B77	S2186T	Clutch release foot lever heel pad 1924- 25-26	1	.25
Cidme	24B78	S2188T	Clutch release foot lever heel pad block 1924-25-26	1	.12
Cidry	24B83	S2189T	Clutch release foot lever heel pad pin 1924- 25-26	1	.02
Cidyr	24B79	S2190T	Clutch release foot lever heel pad spring 1924-25-26	1	.02
Ciepy	20B317X	S2191X	Clutch release foot lever bracket assembly	1	.75
Cifdu	20B312	S2195	Clutch release foot lever friction washer	1	.03
Bungi	26B79	S2196V	Clutch release foot lever stop nut	1	.03
Cifys	20E93X	S2197X	Transmission complete less clutch, kick starter pinion and hand lever 1920-21	1	70.00
Cigna	26E33X	S2197RX	Transmission complete less clutch, kick starter pinion and hand lever, 1922-23- 24-25-26	1	70.00
Cigyt	20C21X	S2199X	Transmission case 1920-21	1	18.00
Cibir	22E37X	S2199RX	Transmission case 1922-23-24-25-26	1	18.00

Order by Number.

Give Motor Number.

Use order blanks which will be furnished on application

Code	Factory No.	Part No.	DESCRIPTION	No. Used	Price Each
Cihvy	20C21X1	S2203X1	Transmission case and cover assembly 1920-21	1	\$22.00
Cijer	24E11X	S2203RX1	Transmission case and cover assembly 1922-23-24-25-26	1	22.00
Cijuv	20B797	S2205	Transmission case and crank case shim .003 thick	4	.03
Cikar	20B798	S2205A	Transmission case and crank case shim .005 thick	4	.03
Afyfe	20B340S	S2207	Transmission case and frame anchor bolt 1920-21	1	.10
Cilru	22B261S	S2207R	Transmission case and frame anchor bolt 1922-23-24-25-26	1	.10
Afzec	22B493	S327	Transmission case and frame anchor bolt fibre washer	1	.01
Agedo	B16610	N1688	Transmission case and frame anchor bolt washer 1922-23-24-25-26	1	.03
Cimpu	20B258S	S332	Transmission case and frame anchor bolt nut 1920-21	1	.05
Afaig	18A215	N9129K	Transmission case and frame anchor bolt nut 1922-23-24-25-26	1	.05
Afasq	19B116S	N246	Transmission case and frame anchor bolt nut lock washer 1920	1	.01
Agayo	20B259S	S329	Transmission case and frame anchor bolt nut lock washer 1922-23-24-25-26	1	.01
Agdaq	20B238S	N1694P	Transmission case and frame anchor bolt nut cotter pin	1	.01
Cinyf	20B118	S2211	Transmission case oil filler cap 1920-21	1	.15
Ciojt	20B24	S2215	Transmission case countershaft bushing right 1920-21	1	.25
Ciord	22B271	S2215R	Transmission case countershaft bushing right 1922-23-24-25-26	1	.25
Cipaw	20B23	S2219	Transmission case countershaft bushing left 1920-21	1	.30
Ciphu	22B272	S2219R	Transmission case countershaft bushing left 1922-23-24-25-26	1	.30
Cipye	20B41	S2223	Transmission case and cover stud short	7	.03
Cirdo	20B40	S2227	Transmission case and cover stud long	1	.05
Akapo	A28160	N2252	Transmission case and cover stud nut	8	.03
Alemo	19B113S	N736	Transmission case and cover stud nut lock washer	8	.01
Adbyo	16A68	N174	Transmission case and cover stud dowel pin 1920-21-22-23-24-25	2	.03
Cisfo	22B241	T2229	Transmission case oil drain screw 1925-26	1	.05
Afisu	E35061	N266	Transmission case oil drain screw leather washer 1925-26	1	.01
Citac	20C16X	S2231X	Transmission case cover assembly 1920-21-22-23	1	4.00
Citde	24D4X	S2231TX	Transmission case cover assembly 1924-25-26	1	4.00
Cipye	20B41	S2223	Transmission case cover and cap stud	2	.03

Order by Number.

Give Motor Number.

Use order blanks which will be furnished on application

Code	Fact No.	Part No.	DESCRIPTION	No. Used	Price Each
Akapo	A28160	N2252	Transmission case cover and cap stud nut	2	\$.03
Alemo	19B113S	N736	Transmission case cover and cap stud nut lock washer	2	.01
Civho	20B4	S2243	Transmission case cover cap	1	.50
Civuj	20B338	S2247	Transmission case cover cap breather valve 1920-21-22-23	1	.05
Ciwoj	20C6	S2251	Transmission main shaft	1	3.75
Ciyhe	20B18	S2255	Transmission main shaft thrust collar .096 thick	1	.05
Ciymb	20B195	S2259	Transmission main shaft thrust collar .090 thick	1	.05
Ciyul	20B31	S2263	Transmission main shaft driver	1	2.25
Cizlo	20B134S	S2267	Transmission main shaft driver key	1	.03
Clahr	20B38	S2271	Transmission main shaft driver nut	1	.10
Clalv	20B757	S2275	Transmission main shaft driver nut lock washer	1	.01
Clapz	20B847	S2276	Transmission sprocket 19 teeth	1	1.50
Clavg	21B82	S2277	Transmission sprocket 17 teeth optional	1	1.50
Clehs	16B40	N5088	Transmission sprocket 21 teeth optional	1	1.50
Clemy	G35221	T2278	Transmission sprocket 20 teeth optional	1	1.50
Amilu	25B245	T2280	Transmission sprocket 18 teeth optional	1	1.50
Cleum	F35230	N5092	Transmission sprocket nut	1	.20
Clida	20B124X	S2279X	Transmission sprocket driver gear with bushing	1	5.50
Clijo	G35180	S2283	Transmission sprocket driver gear bushing	1	.60
Clinb	20B22	S2287	Transmission sprocket driver gear collar	1	.20
Clirf	20B138S	S2291	Transmission sprocket driver gear ball bearing	1	5.50
Clizm	20B17	S2295	Transmission sprocket driver gear ball bearing lock nut	1	.40
Clogt	16A164	N5080	Transmission sprocket driver gear felt washer	1	.05
Cloky	20B15	S2297	Transmission sprocket driver gear felt washer retainer	1	.05
Clonc	20C18X	S2299X	Transmission drive gear assembly 1920-21-22-23-24	1	9.00
Amisi	25C76X	S2299UX	Transmission drive gear assembly 1925-26	1	9.00
Clowl	20B14	S2303	Transmission drive gear bushing	1	.60
Cluce	20B20	S2305	Transmission drive gear nut	1	.15
Cluga	20B62	S2307	Transmission drive gear nut lock washer	1	.02
Clump	F35130X	N5046X	Transmission drive gear ball bearing 1920-21-22-23-24	1	6.00
Amnaq	25B116	S2309U	Transmission drive gear ball bearing 1925-26	1	6.00
Cluzu	20B16	S2311	Transmission drive gear ball bearing lock nut	1	.40
Bunin	26B82	T2313V	Transmission drive gear ball bearing oil deflector 1926	1	.05
Coaht	20B25	S2315	Transmission countershaft 1920-21	1	.90

Order by Number.

Give Motor Number.

Use order blanks which will be furnished on application

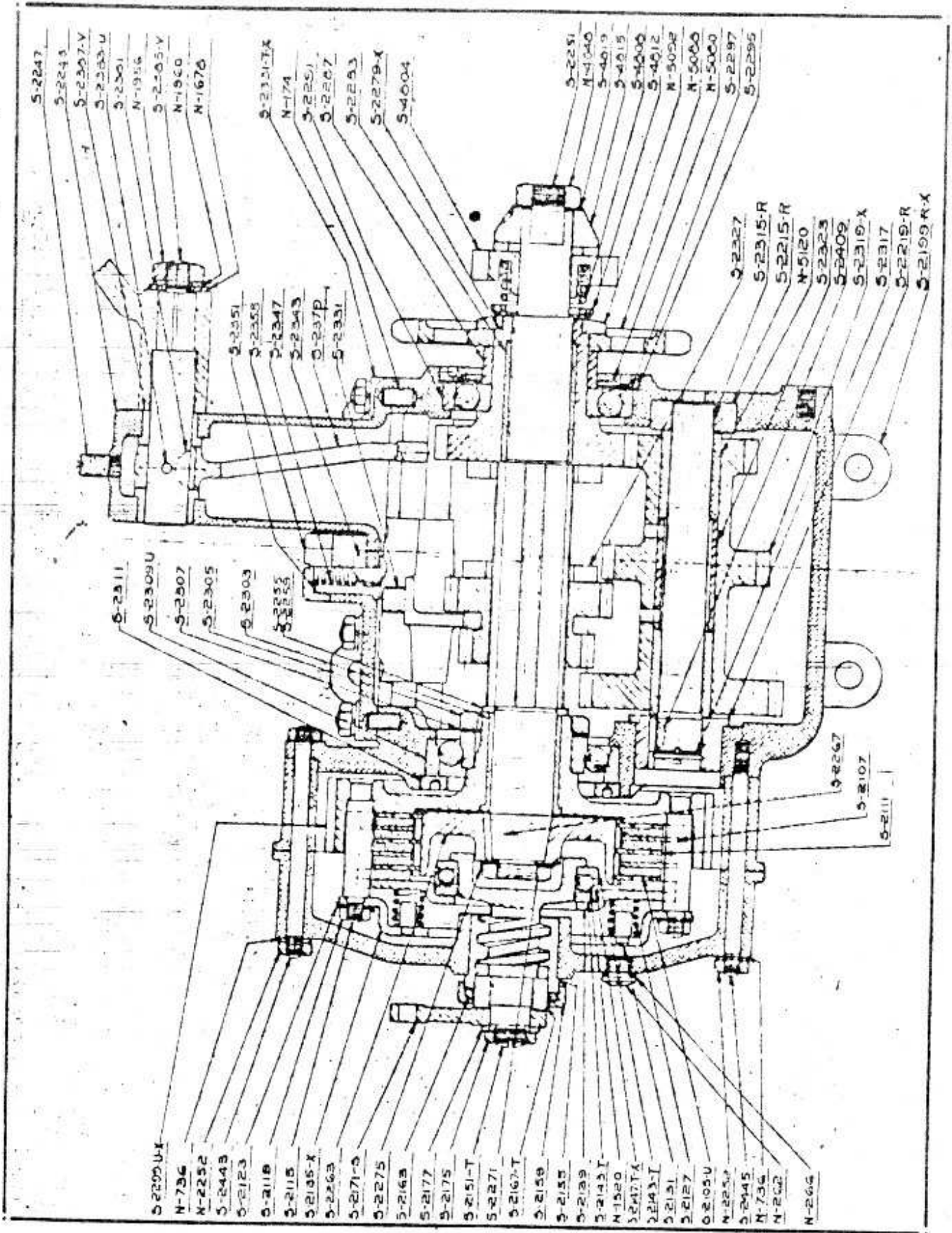

Clutch and Transmission Assembly

Code	Factor No.	Part No.	DESCRIPTION	No. Used	Price Each
Coaph	22B270	S2315R	Transmission countershaft 1922-23-24-25-26	1	\$.90
Cobep	20B133S	S2409	Transmission countershaft key 1922-23-24-25-26	1	.02
Cobpe	20B834	S2317	Transmission countershaft retaining wire	1	.03
Cocpa	20B122X	S2319X	Transmission countershaft gear with bushing	1	6.50
Codox	G75135	N5120	Transmission countershaft gear bushing	2	.50
Coehl	20B28	S2323	Transmission countershaft gear bushing spacer	1	.20
Cofom	20B19	S2327	Transmission sliding gear	1	3.50
Coish	20G8	S2331	Transmission gear shifter fork	1	2.00
Conzi	20B30	S2335	Transmission gear shifter fork shaft	1	.25
Coruk	20B29	S2339	Transmission gear shifter fork shaft retaining screw	1	.03
Cosag	20B137S	S2343	Transmission gear shifter fork ball lock ball	1	.05
Coshe	20B9	S2347	Transmission gear shifter fork ball lock spring	1	.03
Cosmy	20B7	S2351	Transmission gear shifter fork ball lock cover bushing	1	.30
Cosvu	20B8	S2355	Transmission gear shifter fork ball lock cover bushing cap	1	.10
Cotex	20B5	S2359	Transmission gear shifter fork bell crank	1	.75
Cotje	20B6	S2363	Transmission gear shifter fork bell crank stud 1920-21-22-23	1	.15
Ciyzn	24B15	S2363T	Transmission gear shifter fork bell crank stud 1924-25-26	1	.15
Covtu	20B337	S2367	Transmission gear shifter fork bell crank stud cover bushing 1920-21-22-23	1	.15
Cravo	A16250	S2375	Transmission gear shifter fork bell crank stud cover inside washer 1924-25-26	1	.01
Cozuq	20B63S	S2371	Transmission gear shifter fork bell crank stud nut	1	.05
Cravo	A16250	S2375	Transmission gear shifter fork bell crank stud nut washer	1	.01
Ciamt	B16480	N4132	Transmission gear shifter fork bell crank stud nut cotter pin	1	.01
Criba	20B3	S2379	Transmission gear shifter fork bell crank operating lever	1	.75
Crigo	20B136S	S2381	Transmission gear shifter fork bell crank operating lever key	1	.05
Cromi	20B139S	S2383	Transmission gear shifter fork bell crank operating lever taper pin 1920-21-22-23-24	1	.02
Amopi	25B288	S2383U	Transmission gear shifter fork bell crank operating lever taper pin 1925-26	1	.02
Cruko	20B273	S2385	Transmission gear shifter fork bell crank operating lever shaft 1920-21-22-23-24-25	1	.50

Order by Number.

Give Motor Number.

Use order blanks which will be furnished on application

Code	Factory No.	No.	DESCRIPTION	No. Used	Price Each
Bunuq	26B14	S2385V	Transmission gear shifter fork bell crank operating lever shaft 1926	1	\$.50
Cubni	20B27	S2387	Transmission gear shifter fork bell crank operating lever shaft bushing 1920-21-22-23-24-25	2	.35
Barkx	26B97	T2387	Transmission gear shifter fork bell crank operating lever shaft bushing left 1926	1	.35
Buopu	26B15	S2388V	Transmission gear shifter fork bell crank operating lever shaft bushing right 1926	1	.45
Cufaw	24D49X	S2389X1	Transmission gear shifter hand operating lever assembly	1	3.00
Cugru	B16600	N1678	Transmission gear shifter hand operating lever washer	1	.04
Bewip	F1320	N1956	Transmission gear shifter hand operating lever nut	1	.05
Aftu	19B115S	N1960	Transmission gear shifter hand operating lever nut lock washer	1	.01
Culvu	20B455X	S2393X	Transmission drive gear intermediate gear with bushing	1	3.75
Cunyd	20B454	S2401	Transmission drive gear intermediate gear bushing	1	.40
Cusax	20B33	S2405	Transmission drive gear intermediate gear shaft	1	.45
Cutox	20B133S	S2409	Transmission drive gear intermediate gear shaft key	1	.02
Cuwan	20B35	S2413	Transmission drive gear intermediate gear shaft case bushing	1	.20
Cybeq	20B34	S2417	Transmission drive gear intermediate gear shaft case cover bushing	1	.15
Abkuw	16A15	N32	Transmission drive gear intermediate gear roller bearing roller	22	.04
Acafi	20B98	S65	Transmission drive gear intermediate gear roller bearing roller retainer	2	.40
Cygsu	20B36	S2423	Transmission drive gear intermediate gear roller bearing spacer	1	.10
Acaku	20B37	S81	Transmission driver intermediate gear roller bearing thrust washer .061 thick	2	.12
Acepl	20B812	S81A	Transmission driver intermediate gear roller bearing thrust washer .046 thick	2	.12
Acesh	20B813	S81B	Transmission driver intermediate gear roller bearing thrust washer .051 thick	2	.12
Acewa	20B814	S81C	Transmission driver intermediate gear roller bearing thrust washer .056 thick	2	.12
Cyoca	20C14X	S2433X	Transmission gear driver case with bushing	1	4.75
Cypsi	20B768	S2434	Transmission gear driver case plate	1	.15
Cyshu	20B781	S2435	Transmission gear driver case plate screw	2	.03
Alemo	19B113S	N736	Transmission gear driver case plate screw lock washer	2	.01
Cyvju	B21540	N2648	Transmission gear driver case oil filler cap 1922-23-24-25-26	1	.10

Order by Number.

Give Motor Number.

Use order blanks which will be furnished on application

Code	Factory No.	Part No.	DESCRIPTION	No. Used	Price Each
Daacq	20C17	S2437X	Transmission gear driver case cover with bushing	1	\$4.75
Afiko	E35060	N262	Transmission gear driver case cover oil level screw	1	.05
Afisu	E35061	N266	Transmission gear driver case cover oil level screw leather washer	1	.01
Adbyo	16A68	N174	Transmission gear driver case and cover dowel	3	.03
Amraz	24C55	S2438	Transmission drive gear case cover gasket	1	.10
Dafzi	20B314	S2439	Transmission gear driver case and cover front stud	3	.05
Daist	20B43	S2441	Transmission gear driver case and cover center stud	2	.05
Dajmu	20B42	S2443	Transmission gear driver case and cover rear stud	5	.05
Danri	20B44	S2445	Transmission gear driver case and cover lower rear stud	1	.05
Akapo	A28160	N2252	Transmission gear driver case and cover stud nut	21	.03
Alemo	19B113S	N736	Transmission gear driver case and cover stud nut lock washer	21	.01

GASOLINE AND OIL TANK GROUP

Davmi	20E26X1	S2450X1	Gasoline and oil tank complete 1920-21-22	1	\$20.00
Daweq	23E2X1	S2450SX1	Gasoline and oil tank complete 1923	1	20.00
Dawny	24E13X1	S2450TX1	Gasoline and oil tank complete 1924	1	20.00
Amrue	25E41X1	S2450UX1	Gasoline and oil tank complete 1925-26	1	22.00
Buota	26E50X1	S2450VX1	Gasoline and oil tank complete late 1926	1	22.00
Dazhu	24B66X	N1250PX	Gasoline tank injector assembled	1	1.35
Debvu	20B249	N1258P	Gasoline tank injector cylinder	1	.15
Dedvi	C13630	N1262	Gasoline tank injector cylinder nose	1	.10
Deerj	20B246	N1266P	Gasoline tank injector cylinder tank cap	1	.60
Defri	20B244	N1267P	Gasoline tank injector cylinder tank cap washer	1	.03
Dehiq	24B63X	N1270X	Gasoline tank injector plunger with knob	1	.20
Deicq	C13670	N1274	Gasoline tank injector plunger knob	1	.05
Deint	C13680	N1278	Gasoline tank injector plunger guide	1	.10
Dejex	C13690	N1282	Gasoline tank injector plunger spring	1	.03
Dejyd	C13700	N1286	Gasoline tank injector plunger upper washer	1	.01
Delox	C13710	N1290	Gasoline tank injector plunger leather washer 1920-21-22-23	2	.01
Demin	24B65	S1290T	Gasoline injector plunger leather washer 1924-25-26	1	.01
Dengu	C13720	N1294	Gasoline tank injector plunger lower washer 1920-21-22-23	1	.03
Denji	24B64	S1294T	Gasoline injector plunger washer 1924-25-26	2	.01
Deomq	A6210	N1298	Gasoline tank injector plunger nut 1920-21-22-23	2	.03
Clading	A6150	N870K	Gasoline injector plunger nut 1924-25-26	2	.01

Order by Number.

Give Motor Number.

Use order blanks which will be furnished on application

Code	Factory No.	No.	DESCRIPTION	No. Used	Price Each
Buphi	26B88	S2456	Gasoline tank transfer	2	\$.10
Derbi	20B492	S2457	Gasoline tank neutral transfer	1	.05
Desaw	20B2F2X	S2458X	Gasoline tank shutoff valve stem assembly	1	.25
Desim	A20060	N2360	Gasoline tank shutoff valve top nipple	1	.10
Desyc	A20070	N2364	Gasoline tank shutoff valve top nipple leather washer	1	.01
Detly	A20080	N2366	Gasoline tank shutoff valve top nipple check nut	1	.05
Devku	A20090	N2368	Gasoline tank shutoff valve outlet nipple 1920-21-22	1	.20
Devon	23B111	S2460S	Gasoline tank shutoff valve outlet nipple 1923-24-25-26	1	.20
Devyc	20B411	S2386	Gasoline tank and magneto support clip	2	.10
Dewis	A29480	N2388	Gasoline tank and magneto support clip spool	2	.06
Aloni	B22200	N9212	Gasoline tank anchor screw 1920-21-22-23	8	.05
Ajesi	20B491S	S4619	Gasoline tank anchor screw 1924-25-26	4	.05
Alemo	19B113S	N736	Gasoline tank anchor screw lock washer 1920-21-22-23	8	.01
Adicq	19B114S	N214	Gasoline tank anchor screw lock washer 1924-25-26	4	.01
Dibst	17A180	N2394	Gasoline tank anchor screw bushing 1920-21-22-23	8	.05
Dicim	24B35	S2394T	Gasoline tank anchor screw bushing 1924-25-26	4	.05
Dictu	20B234	S2471	Gasoline tank and frame pad 1920-21-22-23	2	.05
Dideq	24B36	S2471T	Gasoline tank and frame pad 1924-25-26	2	.05
Didlu	20B700X	S2475X	Gasoline tank and carburetor tube complete with union nuts 1920-21-22	1	.40
Didyc	23B115X	S2475SX	Gasoline tank and carburetor tube complete with union nuts 1923-24-25-26	1	.40
Difsi	A20150	N2404	Gasoline tank and carburetor tube tank union nut 1920-21-22	1	.08
Digow	A21180	N2510	Gasoline tank and carburetor tube tank union nut 1923-24-25-26	1	.05
Dihyb	A20160	N2406	Gasoline tank and carburetor tube tank cone 1920-21-22	1	.05
Dijfi	23B116	S2476S	Gasoline tank and carburetor tube tank cone 1923-24-25-26	1	.05
Dikju	H20150	N2408	Gasoline tank and carburetor tube carburetor union nut	1	.15
Dilgu	H20160	N2410	Gasoline tank and carburetor tube carburetor cone	1	.15
Diniq	20B245X	N2352PX	Oil tank filler cap assembly	1	.65
Diolk	20B244	N1267P	Oil tank filler cap washer	1	.03
Doaji	20B248	S2479	Oil tank outlet nipple 1920-21-22-23-24-25 and early 1926	1	.20
Bupoq	26B167	S2479V	Oil tank outlet nipple late 1926	1	.20
Dobsu	24B27X1	S2483X	Hand oil pump plunger assembly	1	1.00

Order by Number.

Give Motor Number.

Use order blanks which will be furnished on application

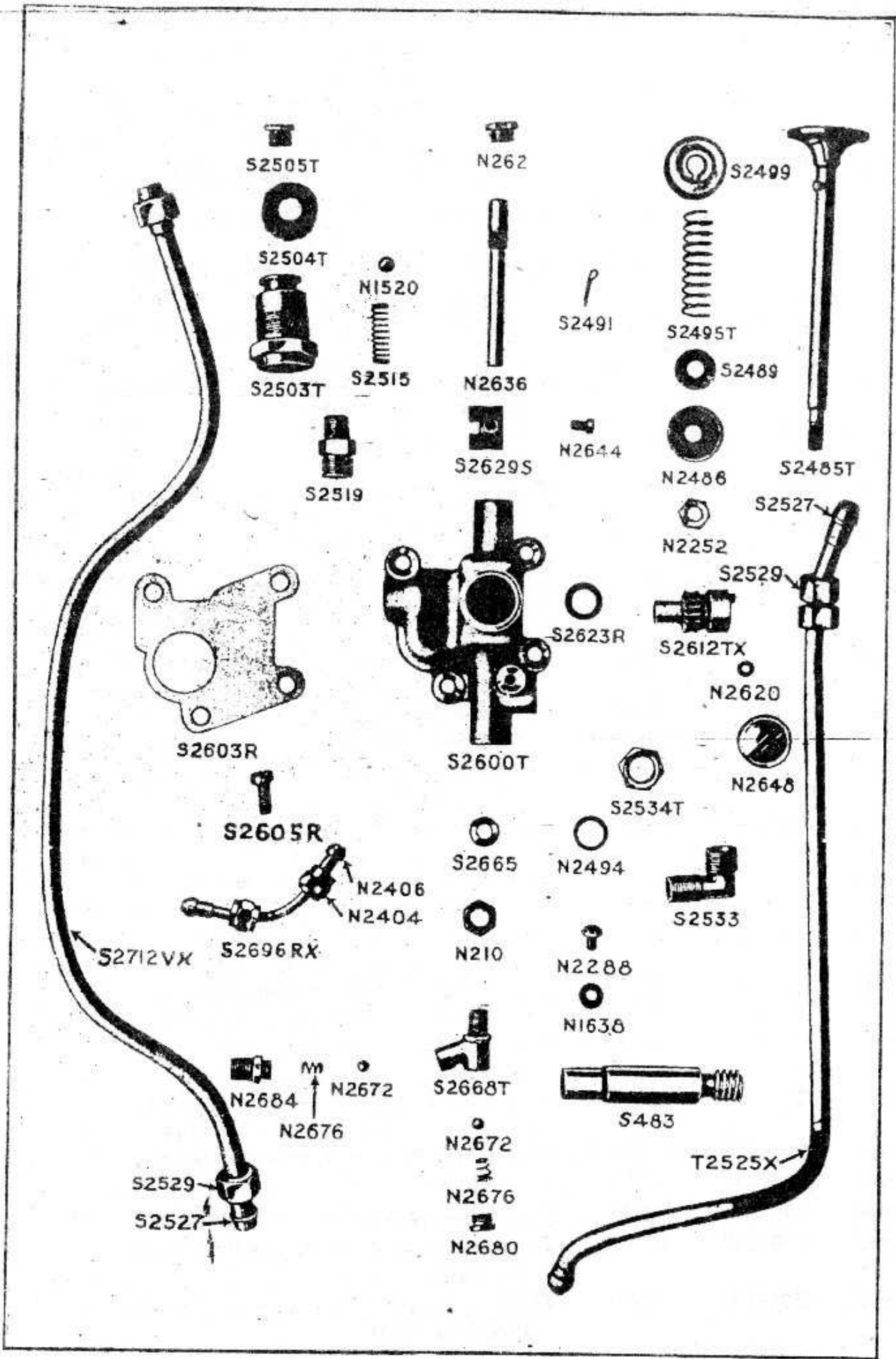

Automatic Oiler Group 1926

Code	Factory No.	No.	DESCRIPTION	No. Used	Price Each
Docmu	20B339X	S2485X	Hand oil pump plunger and knob assembly 1920-21-22-23	1	\$.50
Docwi	24B27X	S2485T	Hand oil pump plunger and knob 1924-25-26	1	.50
Doesi	C35550	S2487	Hand oil pump plunger lock pin	1	.02
Dofow	20B250	S2489	Hand oil pump plunger washer	3	.03
Dohew	A21080	N2486	Hand oil pump plunger leather washer	2	.05
Akapo	A28160	N2252	Hand oil pump plunger nut	1	.03
Dojin	C1372	S2491	Hand oil pump plunger nut cotter pin	1	.01
Dokci	A3060	S2495	Hand oil pump plunger spring 1920-21-22-23	1	.15
Dokes	24B24	S2495T	Hand oil pump plunger spring 1924-25-26	1	.05
Dolvi	20B199	S2499	Hand oil pump cylinder cap	1	.15
Domju	24B56X	S2501X	Hand oil pump valve assembly	1	.75
Donst	20B213	S2503	Hand oil pump valve body 1920-21-22-23	1	.50
Donu	24B56	S2503T	Hand oil pump valve body 1924-25-26	1	.50
Doodi	24B58	S2504T	Hand oil pump valve body leather washer 1924-25-26	1	.02
Dopeq	24B57	S2505T	Hand oil pump valve body leather washer screw 1924-25-26	1	.04
Dopaw	20B214	S2507	Hand oil pump inlet valve spring 1920-21-22-23	1	.03
Dopni	20B215	S2511	Hand oil pump inlet valve spring plug 1920-21-22-23	1	.03
Dorki	20B216	S2515	Hand oil pump outlet valve spring	1	.03
Baest	C18120	N1520	Hand oil pump outlet valve ball	2	.01
Dosti	20B217	S2519	Hand oil pump outlet nipple	1	.10
Drado	25B333X	T2525X	Hand oil pump tube with union nuts	1	.75
Drecq	20B320	S2527	Hand oil pump tube cone	2	.05
Drezu	20B240	S2529	Hand oil pump tube union nut	2	.05
Druch	24B16	S2533	Hand oil pump tube crank case elbow	1	.25
Drudi	24B17	S2534T	Hand oil pump tube crank case elbow check nut	1	.03

AUTOMATIC OILER GROUP

Note: Type A signifies oiler used on Model G is cast with cover.

Type B signifies oiler used on Model G is separate from cover as on Model H.

Dwupy	24C4X	S2600RX	Automatic oiler assembled 1922 (Type B) 23-24-25-26	1	\$7.50
Dwyac	22D10	S2600R	Automatic oiler body 1922-23 (Type B)	1	2.50
Dywif	24C4	S2600T	Automatic oiler body 1924-25-26	1	2.50
Dwymo	22B127	S2603R	Automatic oiler body and gear case cover gasket 1922 (Type B) 23-24-25-26	1	.02
Dwyuh	22B512	S2605R	Automatic oiler body and gear case cover screw 1922 (Type B) 23-24-25-26	4	.05
Dybzi	20B115X	S2612X	Automatic oiler worm gear with pin 1920-21-22	1	.50
Dycuq	23B58X	S2612SX	Automatic oiler worm gear with pin 1923	1	.50
Dydoq	24B26X	S2612TX	Automatic oiler worm gear with pin 1924-25-26	1	.50

Order by Number.

Give Motor Number.

Use order blanks which will be furnished on application

Code	Factory No.	Part No.	DESCRIPTION	No. Used	Price Each
Dydri	B21610	N2614	Automatic oiler worm gear pin	1	\$.05
Dyemi	B21620	N2620	Automatic oiler worm gear pin roller	1	.05
Dygli	20B116	S2617	Automatic oiler worm gear inside bushing (Type A)	1	.25
Dyhis	20B117	S2621	Automatic oiler worm gear outside bushing (Type A)	1	.25
Dyihn	22B129	S2623R	Automatic oiler worm gear thrust washer 1922 (Type B)—23-24-25-26	1	.05
Cinyf	20B118	S2211	Automatic oiler worm gear case cover cap (Type A)	1	.15
Cinyf	20B118	S2211	Automatic oiler worm gear body cap 1922 (Type B)—23	1	.15
Dystu	B21540	N2648	Automatic oiler worm gear body cap 1924-25-26	1	.10
Dylki	16A41	N2636	Automatic oiler plunger	1	.25
Dyney	20B155	S2629	Automatic oiler plunger driving block 1920-21-22	1	.25
Dynti	23B103	S2629S	Automatic oiler plunger driving block 1923-24-25-26	1	.25
Dyovi	B21590	N2644	Automatic oiler plunger driving block set screw	1	.01
Dystu	B21540	N2648	Automatic oiler plunger driving block set screw gear case cover cap (Type A)	1	.10
Dystu	B21540	N2648	Automatic oiler plunger driving block set screw body cap 1922 (Type B)—23-24-25-26	1	.10
Dywex	16A43	N2652	Automatic oiler plunger head bushing (Type A)	1	.20
Ebajy	16A44	N2656	Automatic oiler plunger head bushing cap (Type A)	1	.10
Ebbfu	22B128	T2656	Automatic oiler plunger body cap 1922 (Type B)—23	1	.10
Afiko	E35060	N262	Automatic oiler plunger body cap 1924-25-26	1	.05
Ebbmo	20B119	S2660	Automatic oiler plunger valve bushing (Type A)	1	.75
Ebcyd	16A45	N2660	Automatic oiler plunger valve bushing 1922 (Type B)—23	1	.90
Ebdsi	16A46	N2664	Automatic oiler plunger valve bushing lock nut 1922 (Type B)—23	1	.20
Ebegi	20B120	S2664	Automatic oiler plunger check valve cap (Type A)	1	.15
Ebesq	20B799	S2665	Automatic oiler plunger check valve cap screw lead washer (Type A)	1	.01
Ebghu	A15060	N2672	Automatic oiler check valve ball (Type A)	2	.01
Ebing	B21730	N2676	Automatic oiler check valve ball spring (Type A)	2	.05
Ebjaw	B21740	N2680	Automatic oiler check valve ball screw (Type A)	2	.10

Order by Number.

Give Motor Number.

Use order blanks which will be furnished on application

Code	Factory No.	No.	DESCRIPTION	No. Used	Price Each
Afuzu	E19867	N2288	Automatic oiler primer screw (Type A)	2	
			(Type B)	1	\$.02
Betku	A19040	N1638	Automatic oiler primer screw leather washer (Type A)	2	
			(Type B)	1	.01
Ebpaq	24B18	S2668T	Automatic oiler outlet tube elbow and valve seat	1	.25
Allow	A1230	N210	Automatic oiler outlet tube elbow and valve seat check nut	1	.03
Amsku	20B799	S2665	Automatic oiler outlet tube elbow and valve seat lead washer 1924-25-26	1	.01
Ebpry	A15060	N2672	Automatic oiler outlet tube elbow and valve seat ball (Type B)	2	.01
Ebsnu	B21730	N2676	Automatic oiler outlet tube elbow and valve seat ball spring (Type B)	2	.05
Ecadi	B21740	N2680	Automatic oiler outlet tube elbow cap screw (Type B)	1	.10
Ecatu	B21750	N2684	Automatic oiler outlet tube elbow nipple (Type B)	1	.25
Ecenk	17A321	T2695	Automatic oiler outlet tube motor base nipple (Type B)	1	.30
Echyb	22B513X	S2696RX	Automatic oiler outlet tube with union nuts (Type B)	1	.40
Dihyb	A20160	N2406	Automatic oiler outlet tube cone (Type B)	2	.05
Difsi	A20150	N2404	Automatic oiler outlet tube union nut (Type B)	2	.08
Druch	24B16	S2533	Automatic oiler oil inlet elbow	1	.25
Bupru	26B168	S2533V	Automatic oiler oil inlet elbow late 1926	1	.25
Drudi	24B17	S2534T	Automatic oiler inlet elbow check nut	1	.03
Ecnyc	26B56X	S2712X	Automatic oiler and oil tank connecting tube with union nuts (1920-21-22-23-24-25 and early 26)	1	.75
Burci	26B179X	S2712VX	Automatic oiler and oil tank connecting tube with union nuts late 1926	1	.75
Drecq	20B320	S2527	Automatic oiler and oil tank connecting tube cone	2	.05
Drezu	20B240	S2529	Automatic oiler and oil tank connecting tube union nut 1920-21-22-23-24-25 and early 26	2	.05
Bying	26B169	S2529V	Automatic oiler and oil tank connecting tube union nut late 1926	2	.05
FRONT MUD GUARD GROUP					
Edrax	20E25X	S2750X	Front mud guard complete with braces 1920-21-22-23	1	\$6.00
Edrew	24D41X	S2750TX	Front mud guard complete with braces 1924 early 25	1	6.00
Azija	25D60X	S2750UX	Front mud guard complete with braces late 1925-26	1	6.00
Edugi	23B99	N2752K	Front mud guard and fork crown clip	1	.15

Order by Number.

Give Motor Number.

Use order blanks which will be furnished on application

Code	Factor No.	Part No.	DESCRIPTION	No. Used	Price Each
Efbyd	20B268	S2756	Front mud guard and fork crown clip reinforcement	1	\$.05
Efezi	17A322	T2755	Front mud guard and fork crown clip rivet	2	.01
Efgli	20D22X	S2759X	Front mud guard brace assembly 1920-21-22-23	1	1.25
Efgyf	24D42X	S2759TX	Front mud guard brace assembly 1924-25-26	1	1.25
Efklu	20D20	S2763	Front mud guard front brace 1920-21-22-23	1	.40
Efkry	24D31	S2763T	Front mud guard front brace 1924-25-26	1	.40
Efspi	20D21	S2767	Front mud guard rear brace 1920-21-22-23	1	.40
Efstu	24D32	S2767T	Front mud guard rear brace 1924-25-26	1	.40
Efezi	17A322	T2755	Front mud guard and brace rivet	4	.01
Efyax	20B235	S2771	Front mud guard brace bracket	2	.10
Egbru	20B874S	S2773	Front mud guard brace and bracket rivet	8	.01
REAR MUD GUARD GROUP					
Egobi	20D41X	S2836X	Rear mud guard complete with clips and stand carrier 1920-21-22	1	\$5.50
Egphi	23D4X	S2836SX	Rear mud guard complete with clip brace and stand carrier 1923	1	5.50
Egraf	24E52X	S2836TX	Rear mud guard complete with brace and stand carrier 1924-25-26	1	5.50
Egrex	22B262	S2837	Rear mud guard center support plate 1920-21-22-23	1	.15
Egsty	E33555	N9148	Rear mud guard center support plate and frame screw 1920-21-22-23	1	.08
Intruded	E22202	N2884	Rear mud guard center support screw 1924-25-26	1	.05
Efbyd	20B268	S2756	Rear mud guard center support reinforcement 1924-25-26	1	.05
Adicq	19B114S	N214	Rear mud guard center support plate and frame screw lock washer	1	.01
Ehand	20B296	S2841	Rear mud guard and saddle bracket plate clip 1920-21-22	1	.10
Ehbex	20B270	S2845	Rear mud guard and saddle bracket clip reinforcement 1920-21-22	1	.05
Ehbyf	16A213	S2849	Rear mud guard and saddle bracket clip rivet 1920-21-22	4	.01
Ehcox	A26160	N2848	Rear mud guard and saddle bracket clip screw 1920-21-22	2	.05
Akapo	A28160	N2252	Rear mud guard and saddle bracket clip screw nut 1920-21-22	2	.03
Alemo	19B113S	N736	Rear mud guard and saddle bracket clip screw nut lock washer 1920-21-22	2	.01
Ehdux	E22202	N2884	Rear mud guard lower front screw	1	.05
Chysk	19A37	N4278M	Rear mud guard lower front screw nut	1	.03
Adicq	19B114S	N214	Rear mud guard lower front screw nut lock washer	1	.01
Ehnsi	20B269	S2861	Rear mud guard lower front reinforcement	1	.05

Order by Number.

Give Motor Number.

Use order blanks which will be furnished on application

Code	Factory No.	Part No.	DESCRIPTION	No. Used	Price Each
Ehnyq	E22168	N2858	Rear mud guard lower front reinforcement rivet	2	\$.01
Ehrrk	20C45	S2865	Rear mud guard rear support bracket 1920-21-22	1	.15
Ehrth	23D1	S2865S	Rear mud guard brace 1923-24-25-26	1	.40
Ejank	20B271	S2869	Rear mud guard rear support bracket reinforcement 1920-21-22	1	.05
Efezi	17A322	T2755	Rear mud guard rear support bracket rivet 1920-21-22	3	.01
Egsty	E33555	N9148	Rear mud guard brace and frame screw 1923-24-25-26	2	.06
Adfye	19A58	N211	Rear mud guard brace and frame screw nut 1923-24-25	2	.03
Adicq	19B114S	N214	Rear mud guard brace and frame screw nut lock washer 1923-24-25	2	.01

FRONT WHEEL GROUP

Eycud	20E79X	S2950X	Front wheel complete less tire 1920-21-22-23 and early 24	1	\$10.00
Arogu	25E25X	S2950UX	Front wheel complete less tire 1925	1	10.00
Camyc	25E57X	S2950VX	Front wheel complete less tire 1925-26 (for Balloon tire)	1	10.00
Eydyg	20B401X	S2954X	Hub assembly 1920-21-22-23-24	1	5.00
Amtoh	25B236X	S2954UX	Hub assembly early 1925	1	5.00
Amtuj	25B181X	T2954UX	Hub assembly late 1925-26	1	5.00
Eyewt	J23020X	N2958X	Cone with dust cap 1920-21-22-23-24 and early 25	2	.60
Eyfid	25B318X	N2958RX	Cone with dust cap late 1925-26	2	.60
Eyfyh	J23021	N2962	Cone dust cap 1920-21-22-23-24 early 25	2	.25
Amtie	25B316	S2962U	Cone dust cap late 1925-26	1	.25
Eygif	J23023	N2961	Hollow axle nut 1920-21-22-23-24	2	.10
Amunu	25B177	S2961U	Hollow axle nut early 1925	1	.10
Amvey	25B178	T2961U	Hollow axle nut late 1925-26	1	.10
Eyhig	J23022	N3004	Cone lock washer 1920-21-22-23-24	2	.02
Amvow	25B176	S3004U	Cone lock washer early 1925	2	.02
Amwag	25B175	T3004U	Cone lock washer late 1925-26	2	.02
Eyilk	J23040	N2966	Hollow axle 1920-21-22-23-24 and early 25	1	.40
Eyjaf	22B148	N2966R	Hollow axle late 1925-26	1	.40
Eyjoj	20B384	N2970P	Center axle 1920-21-22-23-24 and early 25	1	.30
Eykag	22B146	N2970R	Center axle late 1925-26	1	.30
Eykok	J23060	N2974	Center axle nut 1920-21-22-23-24 and early 25	2	.10
Cimpu	20B258S	S332	Center axle nut late 1925-26	2	.05
Afttu	19B115S	N1960	Center axle nut lock washer 1920-21-22-23-24 and early 25	2	.01
Afasq	19B116S	N246	Center axle nut lock washer late 1925	2	.01
Bivzu	25B399	T2978	Center axle nut lock washer 1926	2	.01
Eymyp	B16481	N2975	Center axle nut cotter pin 1920-21-22-23-24 and early 25	2	.01
Eynon	B16601S	N5355	Center axle nut cotter pin late 1925-26	2	.01

Order by Number.

Give Motor Number.

Use order blanks which will be furnished on application

Code	Factory No.	Part No.	DESCRIPTION	No. Used	Price Each
Eypal	K23080X	N2982KX	Hub shell with oiler	1	\$3.00
Eypop	H23081	N2986	Hub shell ball cup	2	.60
Eyrep	H23082	N2990	Hub shell ball cup retaining washer	2	.05
Eyryt	A25195	N2994	Hub shell ball $\frac{3}{8}$ "	20	.02
Eyso	D23095X	N2998X	Hub shell oiler	1	.10
Eyter	20C88	S3000	Rim 1920-21-22-23-24-25	1	1.50
Byjoq	25B301	S3000U	Rim 1925-26 used with balloon tire	1	1.50
Eyulm	20B264	S3012	Spoke 1920-21-22-23-24-25	40	.04
Byjtu	25B323	S3012U	Spoke 1925-26 used with balloon tire	40	.04
Eyves	H23142	N3020K	Spoke nipple	40	.02

REAR WHEEL AND BRAKE GROUP

Gajto	24E8X	S3050RX	Rear wheel complete with brake less tire 1920-21-22-23-24-25	1	\$25.00
Byjzi	25E58X1	S3050VX	Rear wheel complete with brake less tire 1925 (balloon) and 1926	1	25.00
Gakra	24D6X	S4000RX	Hub and brake assembly	1	18.00
Galiv	20C25X1	S4004X1	Hub shell with ball cups, rim, spokes and nipples 1920-21	1	10.00
Galux	22C75X1	S4004RX1	Hub shell with ball cups, rim, spokes and nipples 1922-23-24-25	1	10.00
Byksi	25C100X	S4004VX1	Rear wheel hub shell with ball cups, rim, spokes and nipples 1925 (balloon) and 1926	1	10.00
Gamta	20C25X	S4004X	Hub shell with ball cups 1920-21	1	5.50
Gamyo	22C75X	S4004RX	Hub shell with ball cups 1922-23-24-25-26	1	5.50
Ghask	F24107	N4008	Hub shell ball cup	2	.60
Ghans	F24111	N4012	Stationary cone	1	.45
Ghatz	F24115	N4016	Stationary cone dust cap	1	.05
Ghegm	F24112X	N4024X	Adjusting cone with dust cap	1	.70
Ghign	F24112	N4024	Adjusting cone	1	.50
Ghorb	F24116	N4028	Adjusting cone dust cap	1	.20
Ghuhr	D35615	N4034	Hub shell bearing ball $\frac{1}{8}$ "	22	.05
Ghulv	17A134	N4020	Hub shell bearing ball retainer	2	.05
Ghusd	17A135	N4032	Hub shell bearing ball felt washer	2	.05
Ghyef	20B148	S4036	Hollow axle	1	.75
Ghyuj	20B153	S4044	Center axle	1	.25
Gwazy	20B151	S4046	Center axle spacer right	1	.20
Gwizb	20B152	S4049	Center axle spacer left	1	.25
Gwovy	A25280	N4048	Center axle nut	2	.10
Gwuty	16A160	N1856	Chain adjusting screw	2	.05
Gwylo	A17350	N1860	Chain adjusting screw fish tail washer	2	.05
Hactu	20C46X	S4055X	Brake drum and sprocket assembly 1920-21	1	6.00
Hadyn	22C77X	S4055RX	Brake drum and sprocket assembly 1922-23-24-25-26	1	6.00
Haeli	20C27	S4056	Drum 1920-21	1	3.00
Hafhu	22C76	S4056R	Drum 1922-23-24-25-26	1	3.00
Hagyf	A25230	N4060	Brake drum lock nut 1920-21	1	.50
Hakim	22B266	S4060R	Rear wheel brake drum lock nut 1922-23-24-25-26	1	.50

Order by Number.

Give Motor Number.

Use order blanks which will be furnished on application

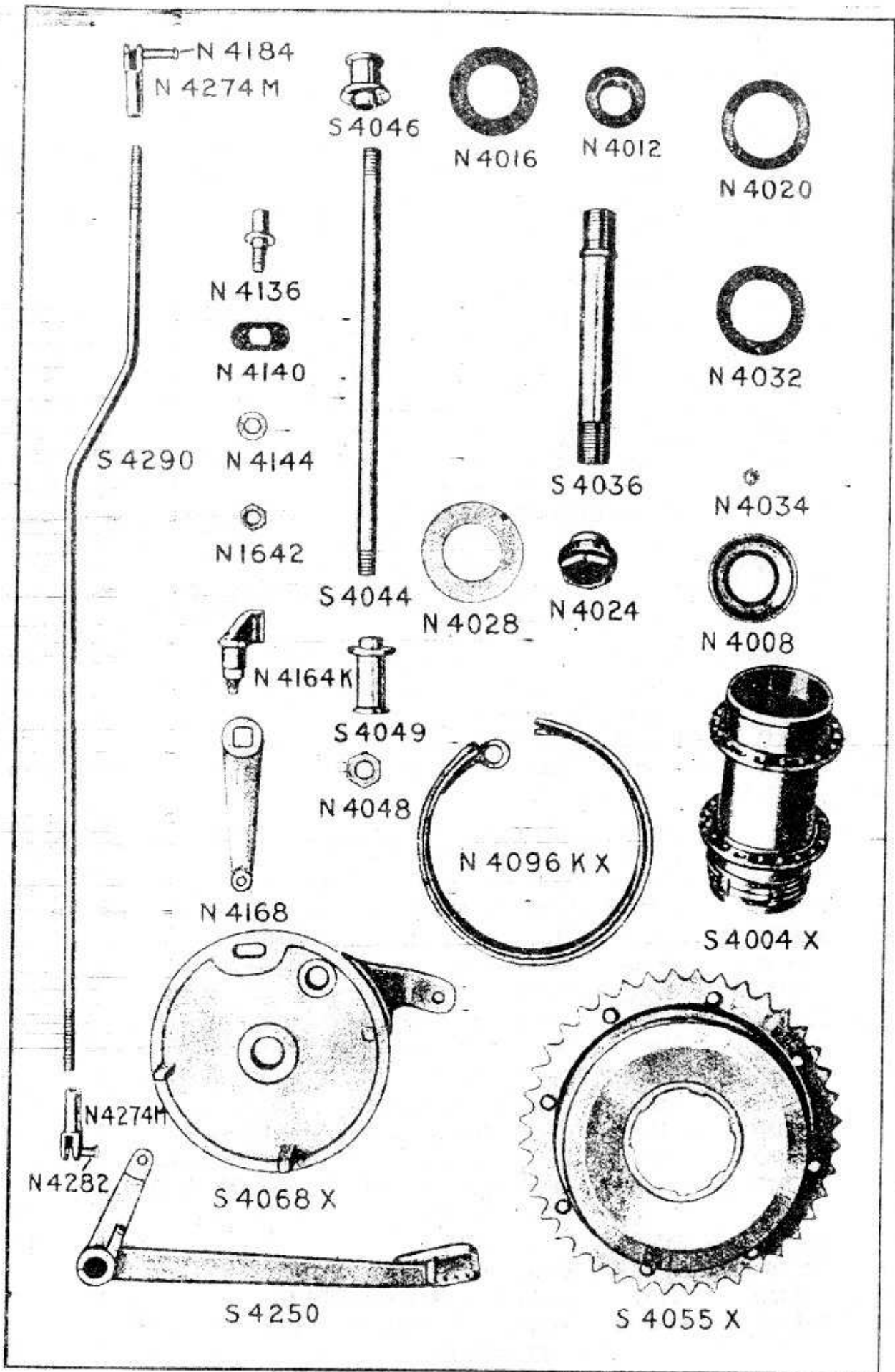

Rear Wheel and Brake Group

Code	Factor No.	Part No.	DESCRIPTION	No Used	Price Each
Halsh	16A17	N4064	Brake drum lock nut washer 1920-21	1	\$.10
Haodi	20D35	S4068	Brake arm	1	3.25
Hapyd	20B236	S4072	Brake arm frame clip	1	.10
Aloni	B22200	N9212	Brake arm frame clip screw 1920-21-22-23	1	.05
Haryc	24B53	S4073T	Brake arm frame clip screw 1924-25-26	1	.05
Haspi	E34209	S4075	Brake arm frame clip screw washer	1	.03
Akapo	A28160	N2252	Brake arm frame clip screw nut	1	.03
Ciamt	B16480	N4132	Brake arm frame clip screw cotter pin 1924-25-26	1	.01
Alemo	19B113S	N736	Brake arm frame clip screw nut lock washer	1	.01
Heand	18C5X1	N4096KX	Internal brake band with end and lining	1	1.80
Hedlu	18C5	N4104K	Internal brake band 1920-21-22-23	1	.50
Hedci	24C51	S4104T	Internal brake band 1924-25-26	1	.75
Hegru	D24175	N4108	Internal brake band end 1920-21-22-23	1	.45
Hehyb	D24180	N4112	Internal brake band end rivet long 1920-21-22-23	1	.01
Heink	D24182	N4116	Internal brake band end rivet short 1920-21-22-23	1	.01
Hekyd	24B176	N4120K	Internal brake band lining	1	.55
Hemsu	K26091	N4128K	Internal brake band lining rivet short	7	.01
Henej	K26093	N4124K	Internal brake band lining rivet long	1	.01
Ciamt	B16480	N4132	Internal brake band cotter pin	1	.01
Heshu	D24190	N4136	Internal brake band anchor stud 1920-21	1	.40
Hibew	22B243	N4136R	Internal brake band anchor stud 1922-23	1	.40
Hibni	24B145	S4136T	Brake band anchor stud 1924-25-26	1	.40
Hicaw	D24195	N4140	Internal brake band anchor stud inside washer	1	.05
Hicyf	D24200	N4144	Internal brake band anchor stud outside washer 1920-21	1	.08
Hifki	22B244	N4144R	Internal brake band anchor stud outside washer 1922-23-24-25-26	1	.03
Bomiq	A1320	N1642	Internal brake band anchor stud nut	1	.05
Ciamt	B16480	N4132	Internal brake band anchor stud nut cotter pin	1	.01
Hikvu	D24205	N4156	Internal brake band anchor stud adjusting screw	1	.03
Adest	A1210	N202	Internal brake band anchor stud adjusting screw nut	1	.03
Hinxt	18A1	N4164K	Internal brake band inside operating lever with shaft	1	.60
Hisri	17A133	N4168	Internal brake band outside operating lever 1920-21-22-23	1	.60
Hitow	24B8	S4168T	Brake band outside operating lever 1924-25-26	1	.60
Bomiq	A1320	N1642	Internal brake band outside operating lever nut	1	.05
Ciamt	B16480	N4132	Internal brake band outside operating lever nut cotter pin	1	.01
Ichew	20C26	S4308	Sprocket	1	3.00

Order by Number.

Give Motor Number.

Use order blanks which will be furnished on application

Code	Factory No.	Part No.	DESCRIPTION	No. Used	Price Each
Morax	G2800	N4340	Duckworth chain $\frac{3}{8}$ " pitch, $\frac{3}{8}$ " roll outside plate		\$.05
Motow	G28070	N4344	Duckworth chain $\frac{3}{8}$ " pitch, $\frac{3}{8}$ " roll pin		.02
Mumox	G28080X	N4348X	Duckworth chain $\frac{3}{8}$ " pitch, $\frac{3}{8}$ " double connecting link		.35
Mylyd	G28081X	N4352X	Duckworth chain $\frac{3}{8}$ " pitch, $\frac{3}{8}$ " roller link		.15
Naish	G28090X	N4356X	Duckworth chain $\frac{3}{8}$ " pitch, $\frac{3}{8}$ " single repair link		.25
Byleq	G28100X	N4360X	Duckworth chain $\frac{3}{8}$ " pitch, $\frac{3}{8}$ " offset link		.25
Negaw	G27050X	N4372X	Duckworth chain $\frac{3}{8}$ " pitch, $\frac{3}{8}$ " connecting link inside plate with pins	1	.08
Neiru	G27060	N4376	Duckworth chain $\frac{3}{8}$ " pitch, $\frac{3}{8}$ " connecting link outside plate	1	.05
Nibyc	G27070	N4380	Duckworth chain $\frac{3}{8}$ " pitch, $\frac{3}{8}$ " connecting link spring	1	.03
Noblu	20E28X	S4384X	Chain guard	1	3.50
Nodsi	20B255	S4388	Chain guard front upper clip	1	.10
Nolyf	C22110	N2766	Chain guard front upper clip rivet	2	.01
Nopej	20B256	S4390	Chain guard front lower clip	1	.10
Nolyf	C22110	N2766	Chain guard front lower clip rivet	2	.01
Nyrax	20B410	S4391	Chain guard front lower clip stud	1	.03
Akapo	A28160	N2252	Chain guard front lower clip stud nut	1	.03
Alemo	19B113S	N736	Chain guard front lower clip stud nut lock washer	1	.01
Ocdyf	20B254	S4404	Chain guard rear clip	1	.10
Nolyf	C22110	N2766	Chain guard rear clip rivet	2	.01

EXTERNAL BRAKE GROUP

(Accessory)

Chdew	20C164X	S4422X	Rear wheel brake arm	1	\$4.00
Chisp	20C131X	S4426X	External brake band and lining	1	2.00
Chwyd	20C162X	S4428X	External brake band with ends	1	1.50
Ojist	24C50	S4430	External brake band	1	.50
Okmew	20B501	S4432	External brake band lining	1	.50
Hemsu	K26091	N4128K	External brake band lining rivet short	7	.01
Hopow	K26092	N4220K	External brake band lining rivet long	1	.01
Okyst	20B494	S4438	External brake band front end 1920-21-22-23	1	.45
Hovcu	B26385	N4236	External brake band front end rivet short 1920-21-22-23	1	.01
Hehyb	D24180	N4112	External brake band front end rivet long 1920-21-22-23	1	.01
Olinz	20B495	S4442	External brake band front end stud	1	.20
Humaq	D24250	N4244	External brake band front end stud washer	1	.02
Ciamt	B16480	N4132	External brake band front end stud cotter pin	1	.01
Olnaq	20B493	S4446	External brake band rear end 1920-21-22-23	1	.40

Order by Number.

Give Motor Number.

Use order blanks which will be furnished on application

Code	Factory No.	Part No.	DESCRIPTION	No. Used	Price Each
Morax	G280	N4340	Duckworth chain $\frac{3}{8}$ " pitch, $\frac{3}{8}$ " roll outside plate		\$.05
Motow	G28070	N4344	Duckworth chain $\frac{3}{8}$ " pitch, $\frac{3}{8}$ " roll pin		.02
Mumox	G28080X	N4348X	Duckworth chain $\frac{3}{8}$ " pitch, $\frac{3}{8}$ " double connecting link		.35
Mylyd	G28081X	N4352X	Duckworth chain $\frac{3}{8}$ " pitch, $\frac{3}{8}$ " roller link		.15
Naish	G28090X	N4356X	Duckworth chain $\frac{3}{8}$ " pitch, $\frac{3}{8}$ " single repair link		.25
Byleq	G28100X	N4360X	Duckworth chain $\frac{3}{8}$ " pitch, $\frac{3}{8}$ " offset link		.25
Negaw	G27050X	N4372X	Duckworth chain $\frac{3}{8}$ " pitch, $\frac{3}{8}$ " connecting link inside plate with pins	1	.08
Neiru	G27060	N4376	Duckworth chain $\frac{3}{8}$ " pitch, $\frac{3}{8}$ " connecting link outside plate	1	.05
Nibyc	G27070	N4380	Duckworth chain $\frac{3}{8}$ " pitch, $\frac{3}{8}$ " connecting link spring	1	.03
Noblu	20E28X	S4384X	Chain guard	1	3.50
Nodsi	20B255	S4388	Chain guard front upper clip	1	.10
Nolyf	C22110	N2766	Chain guard front upper clip rivet	2	.01
Nopej	20B256	S4390	Chain guard front lower clip	1	.10
Nolyf	C22110	N2766	Chain guard front lower clip rivet	2	.01
Nyrax	20B410	S4391	Chain guard front lower clip stud	1	.03
Akapo	A28160	N2252	Chain guard front lower clip stud nut	1	.03
Alemo	19B113S	N736	Chain guard front lower clip stud nut lock washer	1	.01
Ocdyf	20B254	S4404	Chain guard rear clip	1	.10
Nolyf	C22110	N2766	Chain guard rear clip rivet	2	.01

EXTERNAL BRAKE GROUP

(Accessory)

Chdew	20C164X	S4422X	Rear wheel brake arm	1	\$4.00
Chisp	20C131X	S4426X	External brake band and lining	1	2.00
Chwyd	20C162X	S4428X	External brake band with ends	1	1.50
Ojist	24C50	S4430	External brake band	1	.50
Okmew	20B501	S4432	External brake band lining	1	.50
Hemsu	K26091	N4128K	External brake band lining rivet short	7	.01
Hopow	K26092	N4220K	External brake band lining rivet long	1	.01
Okyst	20B494	S4438	External brake band front end 1920-21-22-23	1	.45
Hovcu	B26385	N4236	External brake band front end rivet short 1920-21-22-23	1	.01
Hehyb	D24180	N4112	External brake band front end rivet long 1920-21-22-23	1	.01
Olinz	20B495	S4442	External brake band front end stud	1	.20
Humaq	D24250	N4244	External brake band front end stud washer	1	.02
Ciamt	B16480	N4132	External brake band front end stud cotter pin	1	.01
Olnaq	20B493	S4446	External brake band rear end 1920-21-22-23	1	.40

Order by Number.

Give Motor Number.

Use order blanks which will be furnished on application

	No.			No. Used	Price Each
Hovcu	B26385	N4236	External brake band rear end rivet short 1920-21-22-23	1	\$.01
Hehyb	D24180	N4112	External brake band rear end riveting 1920-21-22-23	1	.01
Ombhu	B26395	N4264	External brake band rear end adjusting screw	1	.10
Howly	B26400	N4268	External brake band rear end adjusting screw pin 1920-21-22-23	1	.05
Bylri	24B144	S4447	External brake band rear end adjusting screw pin 1924-25-26	1	.06
Akazi	A3230	N614	External brake band rear end adjusting screw pin cotter pin	1	.01
Omfo	D24260	N4276	External brake band rear end adjusting screw clevis	1	.25
Omgwi	B26570	N4280	External brake band rear end adjusting screw clevis pin	1	.05
Akazi	A3230	N614	External brake band rear end adjusting screw clevis pin cotter pin	1	.01
Omkl	17A139	N4288	External brake bell crank	1	.60
Omph	20B496	S4452	External brake bell crank stud	1	.15
Omstu	D24275	N4296	External brake bell crank stud washer	1	.01
Ciamt	B16480	N4132	External brake bell crank stud cotter pin	1	.01
Omvyx	25C106X	S4456X	External brake hand lever complete with cable	1	6.00
Akru	22C46	N4006R	External brake hand lever 1920-21-22-23-24	1	1.00
Agudu	25C91	V4006	External brake hand lever 1925-26	1	1.25
Akvi	16A315	S626	External brake hand lever stud 1920-21-22-23-24	2	.20
Moled	D24285	N4010	External brake hand lever screw 1925-26	1	.05
Akdax	A22210	N2758	External brake hand lever stud nut 1920-21-22-23-24	2	.03
Molest	D24290	N4014	External brake hand lever screw lock washer 1925-26	1	.05
Akeas	22B191	N4015RX	External brake hand lever handle bar bracket 1920-21-22-23-24	1	.50
Akemq	A7140	N752	External brake hand lever handle bar bracket rivet 1920-21-22-23-24	2	.01
Akeon	22B192	N4017R	External brake hand lever handle bar bracket block 1922-23-24	1	.25
Akesu	22B193	N4019R	External brake hand lever handle bar bracket block pin 1922-23-24	1	.10
Akidl	17A140	S635	External brake hand lever handle bar clamp 1920-21-22-23-24	1	.25
Iwury	22B194	N4018R	External brake hand lever cable casing upper stop 1920-21-22-23-24	1	.20
Agusa	25B341	V4018	External brake hand lever stud and cable casing upper stop 1925-26	1	1.25
Mossed	25B343	N4022	External brake hand lever stud and cable casing upper stop clip 1925-26	1	.20

Order by Number.

Give Motor Number.

Use order blanks which will be furnished on application

Code	Factory No	Part No.	DESCRIPTION	No Used	Price Each
Wymip	20B2	N6871Q	External brake hand lever stud and cable casing upper stop screw 1925-26	2	\$.03
Opgax	20B776	S4460	External brake wire cable (76 $\frac{3}{8}$ " long)	1	.60
Akemb	D24315	N4033	External brake wire cable upper end sleeve 1920-21-22-23-24	1	.01
Bylzu	25B308	T4033V	External brake wire casing upper end sleeve 1925-26	1	.01
Jasew	20B498	T4034	External brake wire cable lower end sleeve	1	.02
Orimj	20B777	S4464	External brake wire cable casing (71 $\frac{3}{8}$ " long)	1	1.25
Aknew	D24325	N4042	External brake wire cable casing end cap	2	.05
Akodo	17A181	N4046	External brake wire cable casing handle bar clip	2	.05
Judax	20B499	T4054	External brake wire cable casing lower stop	1	.15
Akdax	A22210	N2758	External brake wire cable casing lower stop nut	2	.03
Ayfew	18A88	N874K	External brake wire cable casing rear mud guard clip	1	.03
Implied	A22120	N2828	External brake wire cable casing rear mud guard clip screw	1	.01
Deared	A14140	N1408	External brake wire cable casing rear mud guard clip screw nut	1	.01
Akosh	19B112S	N2808	External brake wire cable casing rear mud guard clip screw nut lock washer	1	.01
Osind	20B778	S4470	External brake wire cable release spring	1	.03
Kadaw	20B497	T4092	External brake wire cable shackle	1	.05
Kafri	17A163X	N4098X	External brake wire cable shackle pin with key	1	.15
Kanst	17A163	N4098	External brake wire cable shackle pin	1	.10
Kaotz	17A164	N4102	External brake wire cable shackle pin key	1	.01
Karth	17A165	N4106	External brake wire cable shackle pin key pin	1	.01
Kasti	17A166	N4110	External brake wire cable shackle pin spring	1	.06

REAR STAND GROUP

Pamli	22D49X	S4500RX	Rear stand assembly 1920-21-22-23	1	\$3.50
Pamoq	24D23X	S4500TX	Rear stand assembly 1924-25-26	1	2.50
Paxaw	G19968	N2354	Rear stand friction spring	2	.06
Paxyc	16A175	N4540	Rear stand friction spring sleeve	2	.10
Pebyd	G33106	N4544	Rear stand friction spring sleeve washer	2	.02
Pefyb	E22204	N4548	Rear stand friction spring sleeve screw	2	.08
Pelex	G33110	N4552	Rear stand spring carrier 1920-21-22-23	1	.25
Peliq	24C13	S4552T	Rear stand spring carrier 1924-25-26	1	.25
Nolyf	C22110	N2766	Rear stand spring carrier rivet	3	.01

FRONT STAND GROUP

Pigzi	20D57X1	S4562X	Front stand complete with carrier 1920-21-22-23	1	\$4.00
Pijou	24D59X1	S4562TX	Front stand assembly 1924-25-26	1	4.00

Order by Number.

Give Motor Number.

Use order blanks which will be furnished on application

	No.	No.	DESCRIPTION	No. Used	Price Each
Pluni	G33370	N4572	Front stand spring carrier inside	1	\$.20
Pobzu	G33380	N4574	Front stand spring carrier outside	1	.20
Prihn	G3335	N4570	Front stand spring carrier tension spring	1	.03
Pryeq	G33387	N4578	Front stand spring carrier tension spring screw	1	.03
Pubew	G33395	N4580	Front stand spring carrier tension spring screw wing nut	1	.20
Pubyf	F29643	S4581	Front stand spring carrier rivet long	1	.01
Punli	F33032	S4582	Front stand spring carrier rivet short	1	.01
Puomz	D22011	N2824	Front stand spring carrier rivet washer	2	.01
Blowa	20B425	N4585P	Front stand and spring fork bell crank stud	2	.50
Pypax	20B426	S4587	Front stand and spring fork bell crank stud sleeve	2	.10

LUGGAGE CARRIER

Rabew	25D23X	S4600TX	Luggage carrier	1	\$5.50
Egsty	E33555	N9148	Luggage carrier frame front end screw 1920-21-22-23-24	2	.06
Adicq	19B114S	N214	Luggage carrier frame front end screw lock washer 1920-21-22-23-24	2	.01
Rauzu	20B265	S4607	Luggage carrier frame and brace clip 1920-21-22-23-24	4	.10
Reink	20C141	S4609	Luggage carrier frame brace front right 1920-21-22-23-24	1	.75
Reksu	20C142	S4611	Luggage carrier frame brace front left 1920-21-22-23-24	1	.75
Replu	20C50	S4615	Luggage carrier frame brace rear 1920-21-22-23-24	2	.75
Ajesi	20B491	S4619	Luggage carrier frame brace and clip screw 1920-21-22-23-24	4	.05
Adfye	19A58	N211	Luggage carrier frame brace and clip screw nut 1920-21-22-23-24	4	.03
Adicq	19B114S	N214	Luggage carrier frame brace and clip screw nut lock washer 1920-21-22-23-24	4	.01
Rēvmi	E22204	N4548	Luggage carrier frame brace lower screw, right 1920-21-22-23-24	1	.08
Adfye	19A58	N211	Luggage carrier frame brace lower screw nut, right 1920-21-22-23-24	1	.03
Adicq	19B114S	N214	Luggage carrier frame brace lower screw nut lock washer, right 1920-21-22-23-24	1	.01
Egsty	E33555	N9148	Luggage carrier frame brace lower screw left 1920-21-22-23-24	1	.06
Avfag	23B18	V2839	Luggage carrier and fork end screw 1925-26	2	.08
Adicq	19B114S	N214	Luggage carrier frame brace lower screw lock washer left 1920-21-22-23-24	1	.01
Adfye	19A58	N211	Luggage carrier frame brace lower screw nut left 1920-21-22-23-24	1	.03
Unful	20B525	S5448	Luggage carrier and mudguard clip 1925-26	1	.05
Algia	D24305	N1634	Luggage carrier and mudguard clip screw 1925-26	2	.03

Order by Number.

Give Motor Number.

Use order blanks which will be furnished on application

Code	Factor No	Part No.	DESCRIPTION	No. Used	Price Each
Adest	A121	N202	Luggage carrier and mudguard clip screw nut 1925-26	2	\$.03
Husked	19B112S	N2808	Luggage carrier and mudguard clip screw nut lock washer 1925-26	2	.01

KICK STARTER GROUP

Rhelz	20C9X	S4704X	Kick starter crank and gear segment with foot lever	1	\$5.50
Rhezn	20C9	S4704	Kick starter crank and gear segment	1	4.75
Rhodt	19B61	N4716P	Kick starter crank foot lever	1	.50
Rhonf	19B106S	N4720P	Kick starter crank foot lever screw	1	.15
Rhown	E34208	N4728	Kick starter crank foot lever rubber	1	.20
Agedo	B16610	N1688	Kick starter crank foot lever rubber inside washer	1	.03
Rhumf	G34537	N4736	Kick starter crank foot lever rubber outside washer	1	.03
Rhypp	A22150	N4412	Kick starter crank foot lever rubber outside washer screw	1	.03
Rirax	20B11	S4744	Kick starter crank spring 1920-21	1	.10
Rixmi	22B168	S4744R	Kick starter crank spring 1922-23-24-25-26	1	.10
Rohmi	20B327	S4748	Kick starter crank stop	1	.25
Rolyd	20B328	S4756	Kick starter stop reinforcement	1	.10
Alafe	A26160	N2848	Kick starter stop screw 1920-21-22-23	2	.05
Romaq	24B55	S4758T	Kick starter crank stop stud 1924-25-26	1	.03
Alemo	19B113S	N736	Kick starter crank stop screw lock washer	2	.01
Akapo	A28160	N2252	Kick starter crank stop stud nut 1924-25-26	1	.03
Bymax	20B123X	S4772X	Kick starter crank stud assembly early 1920	1	1.25
Tsets	20B878X	S4773X	Kick starter crank stud assembly 1920-21	1	1.25
Tsixy	22B169	S4773R	Kick starter crank stud 1922-23	1	1.25
Tsogh	24B13	S4773T	Kick starter crank stud 1924-25-26	1	1.25
Bymin	24B14	S4774U	Kick starter stud lock washer 1925	1	.02
Bymji	19B120S	N9096	Kick starter stud lock washer 1926	1	.02
Twefy	A25290	N4776	Kick starter crank stud washer 1924-25-26	1	.05
Aniji	E17730	N1708	Kick starter crank stud washer lock ring 1924-25-26	1	.01
Tsyav	20B876	S4777	Kick starter crank stud spring pin 1920-21	1	.02
Tsyro	G34630	N4792	Kick starter crank stud dowel pin 1920-21	1	.03
Gwovy	A25280	N4048	Kick starter crank stud inside nut 1920-21	1	.10
Chedo	19B117S	S2177	Kick starter crank stud inside nut lock washer 1920-21	1	.01
Twark	22B170	S4779R	Kick starter crank stud lock washer 1922-23	1	.02
Twefy	A25290	N4776	Kick starter crank stud outside washer 1920-21-22-23	1	.05
Gwovy	A25280	N4048	Kick starter crank stud outside nut 1920- 21-22-23	1	.10
Chedo	19B117S	S2177	Kick starter crank stud outside nut lock washer 1920-21-22-23	1	.01
Twirm	19B39	S4804	Kick starter pinion	1	1.00
Twosp	19B47	S4808	Kick starter pinion spring	1	.10
Twuby	19B46	S4812	Kick starter pinion spring retainer	1	.10

Order by Number.

Give Motor Number.

Use order blanks which will be furnished on application



S 4772 X



S 4716



S 4812



S 4744



N 4732



S 4815



N 4728



S 4808

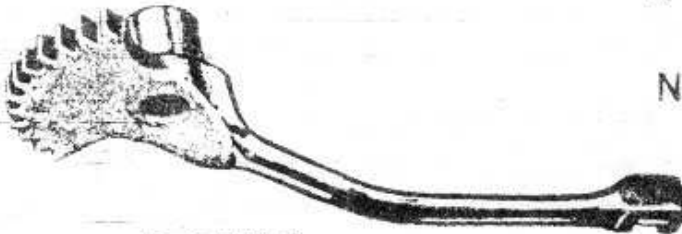

S 4704



N 4736



N 4412



S 4720



S 4804



N 4776



S 2177



N 4048



S 4878



N 4862



S 4850 X



N 4858

Foot Board and Starter Groups

Code	Factory No	Part No.		Used	Each
Twumk	19B	S4815	Kick starter pinion clutch	1	\$1.00
Gwovy	A25280	N4048	Kick starter pinion clutch nut	1	.10
Twayre	20B398	S4819	Kick starter pinion clutch nut lock washer	1	.02
Tzags	20B859	S4823	Kick starter crank stud plate 1920-21	1	.50
Tzamz	20B875S	S4827	Kick starter crank stud plate screw 1920-21	2	.03
Tzaht	20B860	S4831	Kick starter crank stud bracket 1920-21	1	.15
Tzamz	20B410	S4391	Kick starter crank stud plate and bracket stud 1920-21	4	.03
Akapo	A28160	N2252	Kick starter crank stud nut 1920-21	4	.03
Alemo	19B113S	N736	Kick starter crank stud nut lock washer 1920-21	4	.01
Tzelz	20B861	S4843	Kick starter crank stud plate and bracket spacer 1920-21	1	.20

FOOT BOARD GROUP

Tzerg	20C238X1	S4850X1	Foot board complete (right)	1	\$2.00
Tzezn	20C239X1	S4851X1	Foot board complete (left)	1	2.00
Tzilb	20C238X	S4852X	Foot board assembled with cleats (right)	1	1.75
Tzodt	20C239X	S4853X	Foot board assembled with cleats (left)	1	1.75
Tzonf	20C236	N4854S	Foot board	2	1.25
Tzosk	23C36	N4858	Foot board rubber mat	2	.35
Tzubs	16A405	N4859	Foot board rubber mat rivet	24	.01
Tzugy	16B35	N4862	Foot board cleat	4	.30
Tzuld	16A193S	N4870	Foot board cleat rivet	8	.01
Tzuph	C36070	N644	Foot board hinge pin	4	.05
Ciamt	B16480	N4132	Foot board hinge pin cotter pin	4	.01

TOOL BOX GROUP

Unewp	20D87X1	S5400X1	Tool box with lock 1920-21-22	1	\$4.50
Unfav	24D7X1	S5400SX1	Tool box and battery box complete 1923-24	1	7.00
Apirt	25D56X	S5400UX1	Tool box and battery box complete 1925-26	1	7.00
Unfub	20C160	S5416	Tool box door 1920-21-22	1	.40
Ungiz	23C16	S5416S	Tool box door 1923-24-25-26	1	.40
Unhay	20B524	S5421	Tool box hinge wire 1920-21-22	1	.05
Unhib	J32551	N5424	Tool box hinge wire 1923-24-25-26	1	.05
Unhoc	F32600X	N5428	Tool box lock	1	.65
Unibt	F32605	N5432	Tool box lock rivet	3	.01
Unigz	F32610	N5436	Tool box lock link	1	.15
Unilf	F32615	N5440	Tool box lock link rivet	2	.01
Unjeb	F32620	N5444	Tool box lock key	1	.10
Unjuf	20B525	S5448	Tool box and luggage carrier clip 1920-21-22	3	.05
Aljia	D24305	N1634	Tool box and luggage carrier clip screw 1920-21-22	6	.03
Adest	A1210	N202	Tool box and luggage carrier clip screw nut 1920-21-22	6	.03
Akosh	19B112S	N280S	Tool box and luggage carrier clip screw nut lock washer 1920-21-22	6	.01
Unowr	B32111X	N5402X	Monkey wrench	1	.50
Unpag	16B76	N5406	Spark plug wrench	1	.40
Unpij	A32140X	N5414	Screw driver	1	.25

Order by Number.

Give Motor Number.

Use order blanks which will be furnished on application

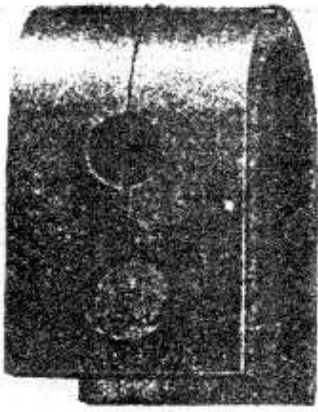

18815

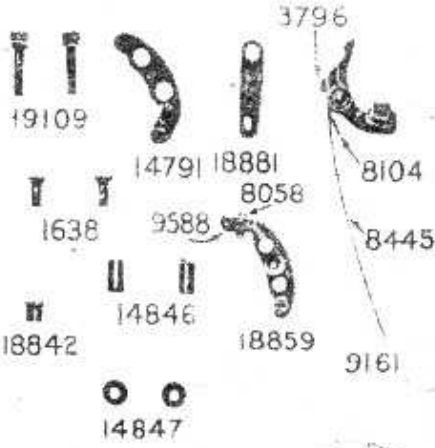

19109

3796

14791 18881

8104

1638

9588

8058

8445

18842

14846

18859

9161

14847



18857



4161



4396

4206

9933

3703

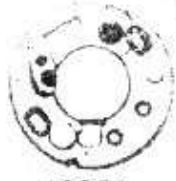

18850

3258



4218



4114

18882

8408

3250

18836

8888

2942

1638

16774

1949

1950

8889



18196

72

18889



18893

4555



4077 R.H.

18886



14724

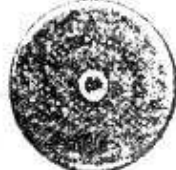

18846

1979



18835



18840



18854

4366

4153

18159



18856

4133

4134

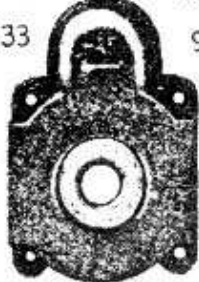

18884

9433



18826



18807

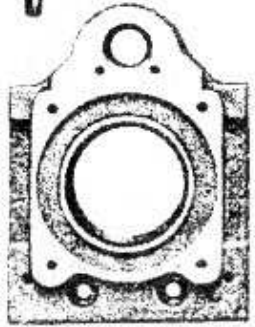

18833

340

226

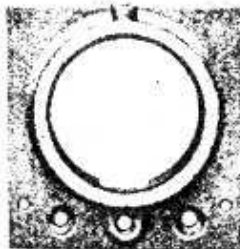

18809

Code	Facto No.	Part No.	DESCRIPTION	No. Used	Price Each
Unpul	E32 0X	N5418	Oil can (accessory)	1	\$.30
Unraj	A32160X	N5422X	Tire repair outfit (accessory)	1	.50
Unril	E32170X	N5426	Pump clips, per pair (accessory)	2	.25
Unrun	E32175X	N5430	Tire pump (accessory)	1	1.25
Unsel	23Q833X	N5434M	Chain repair tool (accessory)	1	.40
Unsup	E32580	N5438A	Open end wrench 41/64, 3/8, 1/2	1	.20
Unten	E32582	N5438B	Open end wrench 45/64, 29/64	1	.20
Untop	E32586	N5438C	Open end wrench 49/64, 37/64	1	.20
Unucy	A32100A	N5439P	Double end socket wrench (accessory)	1	.30
Unuhd	A32100B	N5441P	Double end socket wrench pin (accessory)	1	.10
Unusp	H32598X	N5446	Pliers	1	.50
Unvam	F32650	N5450	Tool roll	1	.50
Unvip	20B453	S5454	Valve hole plug and sleeve wrench 1920- 21-22-23-24	1	.40
Unwep	16B77	N5458	Valve tappet screw wrench	1	.20
Unwus	16A224	N5462	Cylinder stud nut wrench (accessory)	1	.25
Apizu	25B261	S5462U	Cylinder head stud nut wrench 1925-26	1	.25
Unzer	F32596	N5442B	Cylinder stud nut wrench handle	1	.10

AERO MAGNETO GROUP

1920-21

Uobec	20Q450X	N5500PX	Aero magneto complete	1	\$38.00
-------	---------	---------	-----------------------	---	---------

MAGNETS AND COVER

Uobid	3258	N5502	Magneto cover screws with lock washers	4	\$.05
Uobof	18815	N5504P	Magnets, per pair		5.00
Uobug	18857	N5506P	Magneto cover	1	2.75

FRONT AND BACK PLATE

Uobyh	226	N5518	Plate screws with lock washers	4	\$.05
Uocac	340	N5520	Screws with lock washers for back plate cap	4	.05
Uoced	1979	N5522	Brush holder screws with lock washers	6	.05
Uocif	3250	N5528	Distributor brush holder screws	2	.05
Uocog	18807	N5530P	Magneto base	1	2.25
Uocuh	18809	N5532P	Front plate with oiler	1	2.50
Uocyj	18833	N5534P	Back plate with oiler	1	3.00
Uodad	18159	N5535P	Oiler	1	.25
Uodef	18884	N5536P	Back plate cap with gasket	1	2.25
Uodig	4206	N5548	Secondary distributor brush holder com- plete	1	1.50
Uodoh	18826	N5542P	Secondary collector brush holder complete R. H.	1	1.50
Uoduj	18856	N5543P	Secondary collector brush holder complete L. H.	1	1.50
Uodyk	4133	N5544	Rubber gasket, round	1	.15
Uofaf	4134	N5546	Rubber gasket, flat	1	.15
Uofeg	4396	N5524	Carbon brush with spring	1	.15
Uofih	9433	N5558	Carbon brush with spring	1	.15
Uofoj	H48001X	N5554	Cable 16" long	1	.45

Order by Number.

Give Motor Number.

Use order blanks which will be furnished on application

	No.	N		Used	Each
Uofuk	G48000X1	N5556	Cable 24 1/4" long	1	\$.45
Uofyl	2922	N5526	Terminal hood	1	.05
Uogag	4366	N5552	Cover spring and post	1	.40

HIGH TENSION WINDING

Uogeh	3107	N5594	Primary lead and ground connection screw	1	\$.05
Uogij	3703	N5596	High tension winding screws with washers	2	.05
Uogok	4114	N5598	Gap protector	1	.50
Uogul	18882	N5599P	Gap protector bushing	1	.05
Uogym	4151	N5600	Safety gap holder	1	.85
Uohah	18333	N5601P	Safety gap holder screw	4	.05
Uohik	4161	N5602	High tension winding	1	8.50
Uohol	14698	N5603P	Ground clip	1	.05

ROTATING POLE STRUCTURE

Uohum	72	N5560	Key for cam	1	\$.05
Uohyn	8888	N5562P	Cam screw	1	.10
Uojaj	8889	N5563P	Cam washer	1	.05
Uojek	1949	N5564	Shaft nut	1	.15
Uojil	1950	N5568	Shaft washer	1	.05
Uojom	4077	N5570	Secondary spool R. H.	1	1.65
Uojun	4238	N5571P	Secondary spool L. H.	1	1.65
Uojyp	18196	N5569P	Key for secondary spool	1	.05
Uokak	18858	N5572PX	Rotating poles and field structure	1	22.00
Uokel	18885	N5572P	Rotating pole structure	1	6.25
Uokim	52102	N5574P	Cam R. H.	1	1.00
Uokon	23322	N5575P	Drive key	1	.05
Uokup	4153	N5576	Shaft ring	1	.05

BREAKER BOX

UolaI	1638	N5606P	Screw for advance lever	1	\$.05
Uolem	19109	N5607P	Bracket fastening screws	2	.05
Uolin	18850	N5609P	Breaker base	1	1.50
Uolop	9161	N5610P	Breaker bar complete with platinum	1	3.85
Uolyr	18820	N5612P	Advance lever	1	1.50
Uomam	9588	N5618P	Bracket lock screw	1	.05
Uomen	3796	N5619P	Breaker bar spring screw	1	.05
Uomip	8445	N5620P	Breaker bar spring	1	.10
Uomur	14847	N5621P	Bracket insulating washer	2	.05
Uomys	8104	N5622	Buffer spring	1	.05
Uopap	18881	N5623P	Finger spring	1	.05
Uopir	1979	N5522	Breaker bar spring screw	1	.05
Uopos	180	N5638P	Primary lead fastening screw	1	.05
Uoput	8058	N5646P	Contact screw with platinum	1	2.75
Uopyv	14846	N5647P	Bracket insulating bushing	2	.10
Uorar	18846	N5648P	Breaker cover	1	.60
Uorit	14791	N5649P	Contact screw bracket insulation	1	.05
Uorov	18859	N5650P	Contact screw bracket complete with platinum screw	1	4.35
Uoryx	18847	N5651P	Contact screw bracket only	1	.60
Uosas	19109	N5607P	Breaker base fastening screw	2	.05

Order by Number.

Give Motor Number.

Use order blanks which will be furnished on application

Code	Factory No.	Part No.	DESCRIPTION	No. Used	Price Each
Uoset	12490	N5660P	Field poles	1	\$5.25
Uosiv	16774	N5652	Bearing holder screws, long	1	.05
Uosux	1638	N5654	Bearing holder screws, short	1	.05
Uotat	18854	N5656P	Bearing holder with bearing, breaker end	1	8.00
Uotev	18835	N5658P	Bearing holder with bearing, driving end	1	5.00
Uotoy	18886	N5662P	Primary lead	1	.40
Uotuz	4555	N5664	Primary lead strap with screw	1	.05
Uovav	14724	N5668P	Field pole cover	1	.05

CONDENSER

Uovix	4218	N5678	Condenser	1	\$2.50
Uovoz	2942	N5670P	Condenser screw with washer	2	.05
Uovub	18842	N5679P	Condenser support	1	.05

MAGNETO GEAR GROUP

Uozuf	18A26	N882K	Grip control magneto advance lever swivel 1920-21	1	\$.15
Uxafk	A29350	N886K	Grip control magneto advance lever swivel washer 1920-21	1	.02
Uxans	20B411	S2386	Magneto cable support clip	2	.10
Uxatz	A29480	N2388	Magneto cable support clip spool	2	.06
Uxbeh	25B151	V5684	Magneto and crank case screw	4	.05
Uxbul	20B158X	S5690X	Magneto gear and oil deflector assembly	1	1.50
Uxcik	20B105	S5690	Magneto gear	1	1.35
Uxcum	20B106	S5691	Magneto gear oil deflector	1	.05
Uxdek	20B132	S5696	Magneto gear felt washer	1	.05
Uxdun	A29560	N5692	Magneto gear key	1	.01
Uxejp	1949	N5664	Magneto gear nut	1	.15
Uxewd	1950	N5568	Magneto gear nut washer	1	.05
Uxfim	20B107	S326	Magneto intermediate gear	2	1.00
Uxhys	16A53	N330	Magneto intermediate gear crank case and gear case bushing	4	.40
Uxjep	16A391	N5698	Magneto shim (.006 thick)	1	.03
Uxjyt	16A392	N5700	Magneto shim (.008 thick)	1	.03
Bymku	26B64	S5702	Magneto shim (.012 thick)	1	.05

MAGNETO GROUP

1922-23-24-25-26

SPLITDORF MODEL S-2

Uxluv	22Q457X	N5500RX	Magneto complete	1	\$42.50
Uxmar	22Q458X	N5554R	Magneto cable short (front)	1	.40
Uxmes	22Q459X	N5556R	Magneto cable long (rear)	1	.45

MAGNETS AND COVER

Uxmit	16788	N5703R	Magnet cover screws with lock washers 1672	4	\$.05
Uxmov	50008	N5704R	Magnet	1	3.00
Uxmyz	50033	N5706R	Magnet cover clamps	2	.10
Uxnet	50034	N5708R	Magnet cover	1	.80

Order by Number.

Give Motor Number.

Use order blanks which will be furnished on application

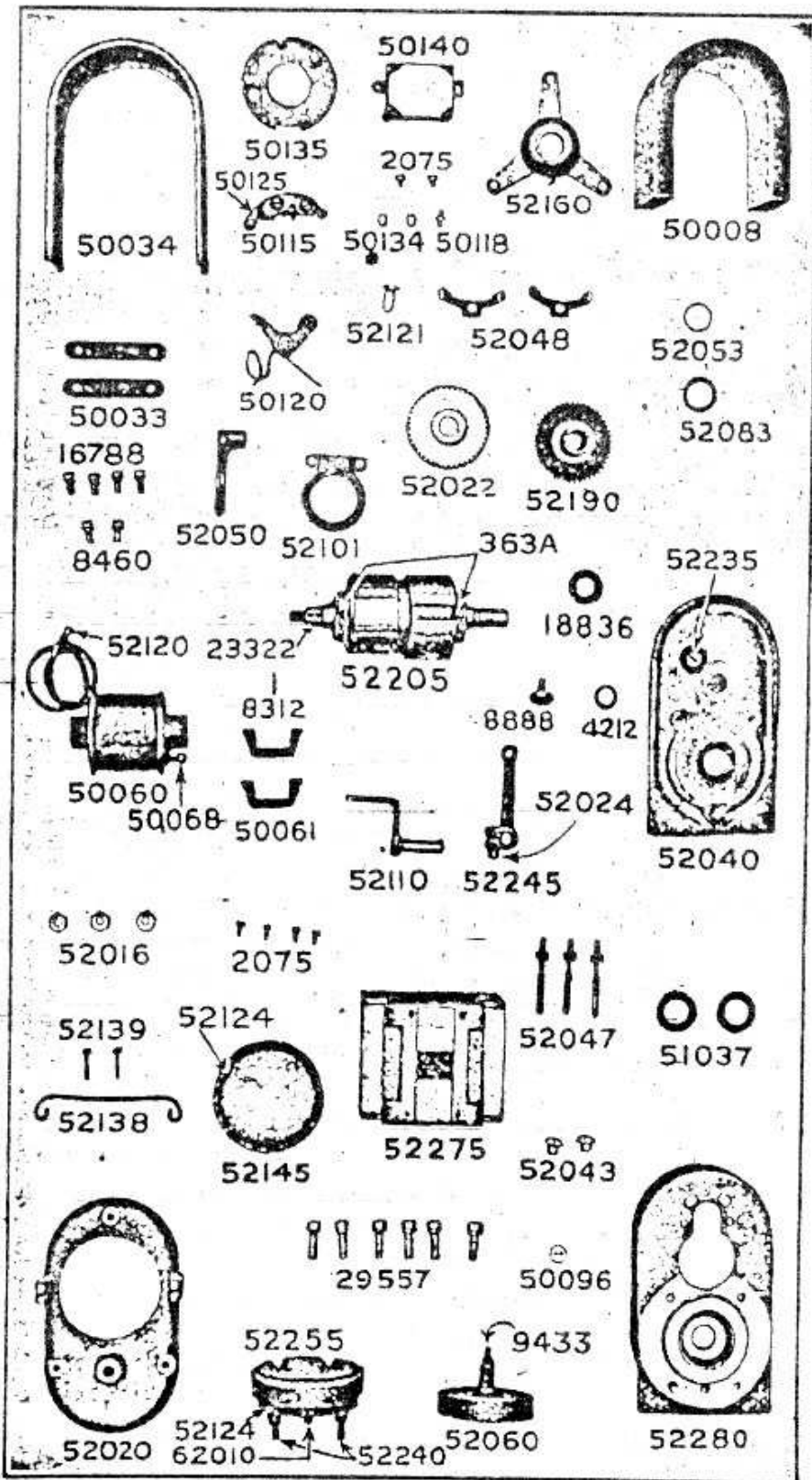

S-2 Magneto Group

FRAME AND FRONT AND BACK PLATE

Code	Factory No.	Part No.	DESCRIPTION	No. Used	Price Each
Uxniv	29557	N5710R	Back and front plate fastening screws with lock washer 23287	6	\$.05
Uxnux	52275	N5712R	Frame	1	7.50
Uxoks	50096	N5714R	Rotation stamp	1	.05
Uxolt	52016	N5716R	Cover nuts with lock washer 224	3	.05
Uxopy	52280	N5718R	Breaker end plate	1	3.00
Uxorb	52040	N5720R	Driver end plate assembly-R. H.	1	2.50
Uxosc	52042	N5722R	Oil stamp disc	1	.05
Uxowg	52043	N5724R	Oil hole screws	2	.05
Uxpat	52047	N5726R	Cover studs	3	.10
Uxpev	52020	N5730R	Cover for breaker end plate	1	1.50
Uxpooy	52128	N5732R	Breaker end plate gasket	1	.20
Uxpuz	52129	N5734R	Grounding terminal gasket	1	.05
Uxriz	52132	N5736R	Grounding terminal screw	1	.05
Uxrob	52133	N5738R	Grounding terminal spring	1	.05
Uxruc	52134	N5740R	Grounding terminal snap ring	1	.05
Uxsay	52285	N5742R	Frame and front plate assembly	1	10.50
Uxsez	52235	N5744R	Grounding terminal assembly	1	.25

HIGH TENSION WINDING

Uxsib	2075	N5746R	High tension winding clamp screws	4	\$.05
Uxsoc	8312	N5748R	High tension connector spring	1	.05
Uxsud	8460	N5750R	Safety gap screws with lock washers 3033	2	.10
Uxtaz	50060	N5752R	High tension winding with primary leads	1	6.50
Uxtde	50061	N5754R	High tension winding clamps	2	.10
Uxteb	50068	N5756R	Ground clip	1	.05
Uxtod	52050	N5758R	High tension connector	1	.75
Uxtuf	52100	N5760R	Safety gap	1	.25
Uxtyg	52120	N5762R	Primary lead	1	.40
Uxuhr	52121	N5764R	Primary lead clip	1	.05

ROTATING POLE STRUCTURE

Uxukt	363-A	N5766R	Ball bearings	2	\$1.50
Uxulv	1949	N5564	Shaft nut	1	.10
Uxupz	1950	N5568	Shaft nut washer	1	.05
Uxurc	8888	N5562P	Cam screw	1	.10
Uxusc	4212	N5563P	Cam screw lock washer	1	.05
Uxuzk	18836	N5574P	Cam 42° R. H.	1	1.00
Uxvec	23322	N5575P	Key for drive end	1	.05
Uxvid	23322	N5575P	Key for pinion	1	.05
Uxvof	51037	N5770R	Felt washer for bearings	2	.05
Uxvug	52010	N5772R	Rotating pole structure—less bearings	3	6.00
Uxvyh	52205	N5774R	Rotating pole and bearings assembly	1	11.00

BREAKER

Uxwac	2075	N5776R	Contact point bracket screws	2	\$.05
Uxwed	14847	N5621P	Contact point bracket insulating washers	2	.05
Uxwif	52330	N5778R	Breaker base assembly	1	2.60

Order by Number.

Give Motor Number.

Use order blanks which will be furnished on application

Code	Factory No.	Part No.	Part Name	No. Used	Price Each
Uxwog	52325	N5780R	Contact point bracket assembly	1	\$.85
Uxwuh	50115	N5782R	Condenser stud	1	.05
Uxwyj	50119	N5784R	Cam wick	1	.05
Uxyad	52320	N5786R	Breaker bar assembly	1	1.25
Uxyef	50125	N5788R	Contact point bracket insulation	1	.05
Uxyig	50134	N5790R	Condenser fastening nuts with lock washer 3033	2	.05
Uxyoh	50135	N5792R	Breaker base and stud assembly	1	.50
Uxyuj	50140	N5794R	Condenser assembly	1	2.50
Uxzaf	52024	N5796R	Advance lever tightening screw	1	.05
Uxzeg	52245	N5798R	Advance lever assembly	1	.50
Uxzih	52048	N5800R	Breaker base clamps	2	.10
Uxzoj	52110	N5802R	Advance lever crank	1	.50

DISTRIBUTOR

Uxzuk	9433	N5558	Distributor disc brush and spring	1	\$.15
Uxzyl	18309	N5804R	Distributor gear spider fastening screw	1	.05
Vlabd	52022	N5806R	Distributor pinion	1	1.40
Vlahk	52053	N5808R	Distributor gear shaft snap ring	1	.05
Vlaln	52055	N5810R	Distributor gear spider assembly	1	5.00
Vlamp	52060	N5812R	Distributor disc	1	1.50
Vlavy	52190	N5814R	Distributor gear	1	3.50
Vlawz	52083	N5816R	Distributor bearing washers	2	.05
Vlejm	52124	N5818R	Distributor block gasket	1	.05
Vlelp	52124	N5820R	Distributor block cover gasket	1	.05
Vleps	52140	N5822R	Distributor block less cover and brushes	1	2.00
Vlerv	52145	N5824R	Distributor block cover	1	.50
Vlety	52138	N5826R	Distributor block clamping spring	1	.05
Vlevz	52139	N5828R	Distributor block clamping spring pins	2	.05
Vlewb	52255	N5830R	Distributor block assembly less cover	1	2.50
Vlezd	52240	N5832R	Distributor block brush	2	.15
Vlich	62010	N5834R	Thrust button	1	.15

BATTERY PARTS

Caith	23Q653A	S6700	Jar	1	\$3.50
Cajex	23Q653NX	S6702	Positive group	3	1.30
Cajsu	23Q6530X	S6704	Negative group	3	1.80
Bephu	22Q652R	T6706	Positive plate	6	.50
Beply	22Q652S	T6708	Negative plate	9	.50
Beruq	22Q652D	T6710	Wood separators (Wet)	12	.05
Beski	25Q655C	T6712	Wood separators (Dry)	12	.05
Betca	22Q652E	T6714	Rubber separators	12	.05
Cajyd	23Q653B	S6716	Outside cover 1922-23-24	3	.45
Cajzi	25Q656A	S6718	Outside cover (Indestructible) 1925-26	1	1.50
Cakew	23Q653U	S6720	Separator hold down	6	.05
Beybu	22Q652H	T6722	Connector post sleeve 1922-23-24	4	.10
Beyeh	22Q652P	T6724	Terminal post sleeve 1922-23-24	2	.10
Cakvu	23Q653H	S6726	Lead strap positive	1	.20
Cakwi	23Q653I	S6728	Lead strap negative	1	.20
Biabi	22Q652I	T6732	Filler plugs	3	.15

Order by Number.

Give Motor Number.

Use order blanks which will be furnished on application

Code	Factor No.	Part No.	DESCRIPTION	No. Used	Price Each
Biajo	22Q652U	T6734	Filler plug washers	3	\$.02
Bicej	22Q652W	T6736	Copper terminal large negative	1	.05
Bichu	F71200	T6738	Copper terminal small positive 1925-26	1	.03
Calbu	23Q653L	S6740	Cell connector	2	.05
Bidow	22Q652LX	T6742	Positive lead wire group	1	.25
Calci	23Q653RX	S6752	Negative lead wire group	1	.25
Calmo	23Q653M	S6754	Rubber spacers	12	.05

BATTERY AND BATTERY BOX GROUP

Wryul	25Q656X	N6781SX	Battery complete with cables	1	\$11.50
Wuvsy	F21200	N6787	Battery negative cable terminal	1	.05
Wuvur	20C182X1	S6791X1	Battery box assembled 1920-21-22	1	4.00
Unfav	24D7X1	S5400SX1	Tool box and battery box complete 1923-24	1	7.00
Apirt	25D56X1	S5400UX1	Tool box and battery box complete 1925-26	1	7.00
Wuvys	G73860	N6793	Battery box front 1920-21-22	1	.30
Wuyap	G73865	N6794	Battery box front hinge pin 1920-21-22	2	.05
Wuygd	20C181X	S6795X	Battery box top with insulator 1920-21-22	1	.35
Wuyir	23B23X	S6795SX	Battery box cover complete 1923-24	1	.35
Armdu	25B246	S6795UX	Battery box cover 1925-26	1	.25
Wuymk	23B25	S6796S	Battery box cover strap 1923-24	1	.10
Vrorz	A28150	N4392	Battery box cover strap rivet 1923-24	2	.01
Vrord	22B179X	T6770X	Battery box cover T bolt and nut 1923-24	2	.20
Vrumv	22B117	T6772	Battery box cover T bolt 1923-24	2	.15
Armeq	24B23	S6772T	Battery box cover strap bolt 1925-26	1	.10
Vrurb	D28170	T6774	Battery box cover T bolt wing nut 1923-24-25-26	2	.05
Vryac	22B118	T6776	Battery box cover T bolt clip 1923	2	.05
Vryif	23B54	T6778	Battery box cover block 1923-24	2	.05
Vryuh	19B104S	T6779	Battery box cover block screw 1923-24	4	.01
Arnji	25C36	S6798T	Battery box cover spacer 1925-26	1	.30
Wuylj	18B15	N6809K	Battery box top insulator 1920-21-22	1	.10
Ciamt	B16480	N4132	Battery box top cotter pin 1920-21-22	1	.01
Wuyos	20C167	S6802	Battery box cradle 1920-21-22	1	.50
Wuyso	20B718	S6806	Battery box cradle anchor stud	2	.05
Adfye	19A58S	N211	Battery box cradle anchor stud nut	2	.03
Akosh	19B112S	N2808	Battery box cradle anchor stud nut lock washer	2	.01
Wuyvy	20C168	S6810	Battery box bridge	1	.50
Aleaj	B33560	N732	Battery box bridge and frame screw 1920-21-22-23	1	.08
Romaq	24B55	S4758T	Battery box bridge and frame stud 1924-25-26	2	.08
Alemo	19B113S	N736	Battery box bridge and frame screw lock washer	1	.03
Akapo	A28160	N2252	Battery box bridge and frame stud nut 1924-25-26	2	.01
Wuzre	20B786	S6814	Battery box bridge and frame clamp	1	.03
Aleaj	B33560	N732	Battery box bridge and frame clamp screw	1	.15
Akapo	A28160	N2252	Battery box bridge and frame clamp screw nut	1	.08
				1	.03

Order by Number.

Give Motor Number.

Use order blanks which will be furnished on application

	No.			NO. Used	Price Each
Bafox	26B191	T6852C	Horn switch lower insulator 1922-23-24-25.	1	\$.06
Biflu	26B76	T6852C	Horn switch lower insulator 1928	1	.06
Bifur	26B77	T6852D	Horn switch clip	1	.05
Hulking	20B470S	N2795P	Horn switch clip screw	1	.03
Deomq	A6210	N1298	Horn switch clip screw nut	1	.03
Bigmi	26B106	T6852E	Horn switch wire 22 1/4" long	1	.10
Wyovz	18A127	N6878	Horn switch clip wire horn terminal	1	.05
Akodo	17A181	N4046	Switch cable handle bar clip	2	.05
Wyjja	21B57	N6853Q	Horn bracket 1920-21-22	1	.50
Wyjke	23B120	T6853S	Horn bracket 1924-25-26	1	.50
Bynju	23B42X	S6853SX	Horn bracket assembly 1923	1	.25
Bynli	23B40	S6855S	Horn bracket horn clip 1923	1	.10
Acclaimer	16A311	N294P	Horn bracket horn clip binding screw 1923.	1	.04
Akapo	A28160	N2252	Horn bracket horn clip binding screw nut 1923 .	1	.03
Byobi	23B41	S6857S	Horn bracket handle bar clip 1923 .	1	.05
Nailed	D24160	N4088	Horn bracket handle bar clip binding screw 1923 .	1	.05
Akapo	A28160	N2252	Horn bracket handle bar clip binding screw nut 1925 .	1	.03

AMMETER AND WIRING GROUP

Wyjmo	21C17X	S6860X	Ammeter complete with bracket, switch and cable assembled 1920-21-22-26	1	\$10.00
Wykak	20B793X1	S6860SX	Ammeter complete with bracket 1923-24-25	1	4.00
Wykle	26Q228X	N6860R	Ammeter only 1920-21-22-26	1	3.50
Wykno	20Q225X	S6860S	Ammeter only 1923-24-25	1	3.50
Wykon	21C17	S6862	Ammeter and switch bracket 1920-21-22-26	1	2.00
Wykup	20B793X	S6862SX	Ammeter bracket complete 1923-24-25	1	.50
Byovu	20B795	S6865S	Ammeter bracket clip screw 1923-24-25	1	.02
Byudi	20B794	S6867S	Ammeter bracket clip screw nut 1923-24-25	1	.02
Alaje	A26160	N2848	Ammeter bracket frame clamping screw 1920-21-22-26	1	.05

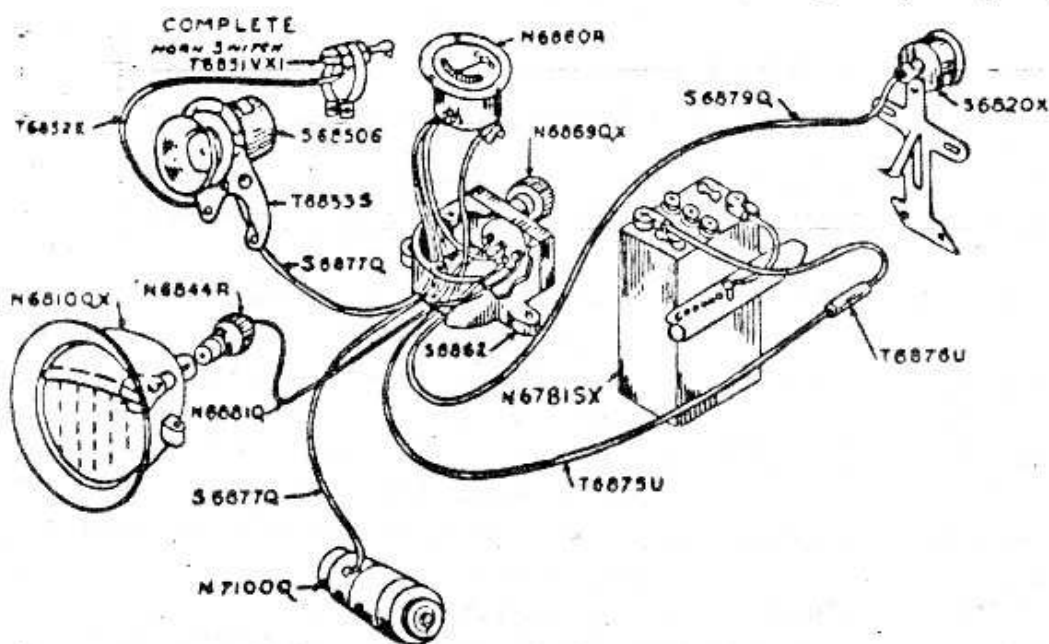

Wiring Diagram 1926

Order by Number.

Give Motor Number.

Use order blanks which will be furnished on application

Code	Factory No.	Part No.	DESCRIPTION	No. Used	Price Each
Wylal	F7434G	N6863	Ammeter anchor screw 1920-21-22-26	3	\$.01
Wylla	21Q806X	N6869QX	Lighting switch complete 1920-21-22-26	1	2.00
Wylop		N6869QA	Lighting switch plate with knob 1920-21-22-26	1	1.25
Wymam		N6869QB	Lighting switch disc 1920-21-22-26	1	.75
Wymip	20B200S	N6871Q	Lighting switch anchor screw 1920-21-22-26	2	.03
Wymne	21B35X	N6873Q	Ammeter to switch cable complete 1920-21-22-26	1	.25
Wynan	21B40X	S6875Q	Ammeter to connection block cable complete 1920-21-22	1	.30
Apalz	25B315X	T6875U	Ammeter to battery cable complete 1926	1	.30
Implied	A22120	N2828	Ammeter to battery cable battery connection screw 1925-26	1	.01
Adest	A1210	N202	Ammeter to battery cable battery connection screw nut 1925-26	1	.03
Akosh	19B112S	N2808	Ammeter to battery cable battery connection screw lock washer 1925-26	1	.01
Aparo	25B314	T6876U	Ammeter to battery cable rubber sleeve 1925-26	1	.05
Caado	D29765		Ammeter to battery cable frame clip 1926	1	.05
Wynep	20B817X	S6875SX	Ammeter connection block and tail light cable complete 1923-24	1	.50
Apasu	25B157X	S6875UX	Ammeter to battery cable complete 1925	1	.50
Wynna	21B41X	S6877Q	Ammeter to horn and generator cable complete 1920-21-22-26	1	.50
Wynro	20B816X	S6877SX	Ammeter to generator, ammeter to horn, ammeter to head lamp cable complete 1923-24-25	1	.75
Wynus	21B42X	S6879Q	Switch to tail lamp cable complete 1920-21-22-26	1	.40
Apawc	25B158	S6879U	Head lamp to tail lamp cable 1925	1	.20
Wyops	21B39X	N6881Q	Head lamp to switch cable complete 1920-21-22-26	1	.35
Wyovz	18A127	N6878	Ammeter terminal		.05
Wyozd	21B34	N6883Q	Switch terminal		.05
Wypir	18A99X	N7172	Cable connection block 1920-21-22-23-24	1	.40
Wyppa	A6110	N7176	Cable connection block screw 1920-21-22-23-24	2	.03
Awzyf	A6210	N1298	Cable connection block screw nut 1920-21-22-23-24	2	.03
Wyput	19B111S	N2220	Cable connection block screw nut lock washer 1920-21-22-23-24	2	.01
Awmtu	D34370	N862K	Cable connection block cable binding screw 1920-21-22-23-24	1	.01

Order by Number.

Give Motor Number.

Use order blanks which will be furnished on application

Code	Factory No.	Part No.	DESCRIPTION	No. Used	Price Each
Anube	A6775	S6847T	Focus spring 1924-26	1	\$.05
Wyfeg	F74180X	N6848	Head lamp bulb 1920-21-22-23	1	.50
Anufo	24Q128	N6848T	Head lamp bulb (Tulite) 1924-25-26	1	.50
Wyfge	F74440X	N6849	Head lamp dimmer bulb 1920-21-22-23	1	.35

TAIL LAMP GROUP

Wyfoj	23C43X1	S6820X	Tail lamp with bracket	1	\$1.75
Wyghe	K74430	N6821	Tail lamp ruby glass	1	.30
Wygko	K74431	N6823	Tail lamp ruby glass retaining ring	1	.10
Anumi		N6824S	Tail lamp lower glass 1923	1	.10
Apabi		N6824T	Tail lamp glass cup 1924-25-26	1	.15
Wygul	20Q131X	N6825PX	Tail lamp switch plug 1920-21-22-23	1	.60
Wyhha	F74440X	N6849	Tail lamp bulb	1	.35
Wyhje	A22150	N4412	Tail lamp bracket and mud guard screw	3	.03
Akapo	A28160	N2252	Tail lamp bracket and mud guard screw nut	3	.03
Alemo	19B113S	N736	Tail lamp bracket and mud guard screw nut lock washer	3	.01
Wyhol	22B207	N6826R	Tail lamp and switch cable rear mud guard clip 1920-21-22	3	.03
Wyhum	23B117	S6826S	Tail lamp and switch cable rear mud guard clip 1923-24-25-26	4	.05
Wyibd	A22120	N2828	Tail lamp and switch cable rear mud guard clip screw 1920-21-22	3	.01
Aljyo	17A365S	S733	Tail lamp and switch cable rear mud guard clip screw nut 1920-21-22	3	.03
Akosh	19B112S	N2808	Tail lamp and switch cable rear mud guard clip screw nut lock washer 1920-21-22	3	.01
Akodo	17A181	N4046	Tail lamp and switch cable frame clip		.05
Bynew	4053		Tail lamp switch plug with pin 1925	1	.35
Bynfy	1107		Tail lamp switch plug pin 1925	1	.05

HORN GROUP

Wyjaj	24Q211X2	S6850SX	Horn complete with bracket and switch 1923-24-25-26	1	\$4.00
Wyjil	24Q211X	S6850S	Horn only 1923-24-25-26	1	3.00
Camvi	24Q214X	N6850Q	Motor driven horn only 1920-21-22	1	5.75
Wyirt	24Q214X2	N6850QX	Motor driven horn with bracket and switch 1920-21-22	1	6.75
Baemo	26B189X1	T6851TX1	Horn switch complete with wire and horn terminal 1922-23-24-25	1	.75
Bieda	26B73X1	T6851VX1	Horn switch complete with wire and horn terminal 1926	1	.75
Baeng	26B189X	T6851TX	Horn switch complete less wire and horn terminal 1922-23-24-25	1	.65
Bieru	26B73X	T6851VX	Horn switch complete less wire and horn terminal 1926	1	.65
Biesq	26B74	T6852A	Horn switch contact spring	1	.03
Baefw	26B190	T6852TB	Horn switch upper insulator 1922-23-24-25	1	.06
Bifeh	26B75	T6852B	Horn switch upper insulator 1926	1	.06

Order by Number.

Give Motor Number.

Use order blanks which will be furnished on application

Code	Factory No.	Part No.		No. Used	Price Each
Anube	A6775	S6847T	Focus spring 1924-26	1	\$.05
Wyfeg	F74180X	N6848	Head lamp bulb 1920-21-22-23	1	.50
Anufo	24Q128	N6848T	Head lamp bulb (Tulite) 1924-25-26	1	.50
Wyfge	F74440X	N6849	Head lamp dimmer bulb 1920-21-22-23	1	.35

TAIL LAMP GROUP

Wyfoj	23C43X1	S6820X	Tail lamp with bracket	1	\$1.75
Wyghe	K74430	N6821	Tail lamp ruby glass	1	.30
Wygko	K74431	N6823	Tail lamp ruby glass retaining ring	1	.10
Anumi		N6824S	Tail lamp lower glass 1923	1	.10
Apabi		N6824T	Tail lamp glass cup 1924-25-26	1	.15
Wygul	20Q131X	N6825PX	Tail lamp switch plug 1920-21-22-23	1	.60
Wyhha	F74440X	N6849	Tail lamp bulb	1	.35
Wyhje	A22150	N4412	Tail lamp bracket and mud guard screw	3	.03
Akapo	A28160	N2252	Tail lamp bracket and mud guard screw nut	3	.03
Alemo	19B113S	N736	Tail lamp bracket and mud guard screw nut lock washer	3	.01
Wyhol	22B207	N6826R	Tail lamp and switch cable rear mud guard clip 1920-21-22	3	.03
Wyhum	23B117	S6826S	Tail lamp and switch cable rear mud guard clip 1923-24-25-26	4	.05
Wyibd	A22120	N2828	Tail lamp and switch cable rear mud guard clip screw 1920-21-22	3	.01
Aljyo	17A365S	S733	Tail lamp and switch cable rear mud guard clip screw nut 1920-21-22	3	.03
Akosh	19B112S	N2808	Tail lamp and switch cable rear mud guard clip screw nut lock washer 1920-21-22	3	.01
Akodo	17A181	N4046	Tail lamp and switch cable frame clip		.05
Bynew	4053		Tail lamp switch plug with pin 1925	1	.35
Bynfy	1107		Tail lamp switch plug pin 1925	1	.05

HORN GROUP

Wyjaj	24Q211X2	S6850SX	Horn complete with bracket and switch 1923-24-25-26	1	\$4.00
Wyjil	24Q211X	S6850S	Horn only 1923-24-25-26	1	3.00
Camvi	24Q214X	N6850Q	Motor driven horn only 1920-21-22	1	5.75
Wyirt	24Q214X2	N6850QX	Motor driven horn with bracket and switch 1920-21-22	1	6.75
Baemo	26B189X1	T6851TX1	Horn switch complete with wire and horn terminal 1922-23-24-25	1	.75
Bieda	26B73X1	T6851VX1	Horn switch complete with wire and horn terminal 1926	1	.75
Baeng	26B189X	T6851TX	Horn switch complete less wire and horn terminal 1922-23-24-25	1	.65
Bieru	26B73X	T6851VX	Horn switch complete less wire and horn terminal 1926	1	.65
Biesq	26B74	T6852A	Horn switch contact spring	1	.03
Baefw	26B190	T6852TB	Horn switch upper insulator 1922-23-24-25	1	.06
Bifeh	26B75	T6852B	Horn switch upper insulator 1926	1	.06

Order by Number.

Give Motor Number.

Use order blanks which will be furnished on application

Note: When used on Scout Model Machine equipped with 26 x 3 tire use 85 Tooth Ring Gear and 26 Tooth Pinion Gear or 72 Tooth Ring Gear and 22 Tooth Pinion Gear.

When used with the Balloon Tire 25 x 3.85, use 85 Tooth Ring Gear and 27 Tooth Pinion Gear or 72 Tooth Ring Gear and 23 Tooth Pinion Gear.

Code	Factory No.	Part No.	DESCRIPTION	No. Used	Price Each
Caafu	25Q346X	S6900X	Speedometer complete (80 mile head) 1922-23-24 (26 x 3 tire)	1	\$17.00
Caasi	25Q342X	S6900TX	Speedometer complete (80 mile head) 1925-26 (Balloon tire)	1	17.00
Cabru	23L24X	S6900BX	Speedometer complete with 80 mile head maximum hand 1922-23-24	1	19.00
Cachu	25L27X	S6900TBX	Speedometer complete with 80 mile head maximum hand 1925-26	1	19.00
Cacri	23L25X	S6900DX	Speedometer complete with 80 mile head luminous dial 1922-23-24	1	20.50
Cadni	25L28X	S6900TDX	Speedometer complete with 80 mile head luminous dial 1925-26	1	20.50
Cadzu	23L26X	S6900FX	Speedometer complete with 80 mile head maximum hand and luminous dial 1922-23-24	1	22.50
Caffi	25L29X	S6900TFX	Speedometer complete with 80 mile head maximum hand and luminous dial 1925-26	1	22.50
Wytve	23Q307X	T6902X	Speedometer head (80 mile)	1	8.20
Cafru	23L18X	T6902BX	Speedometer head (80 mile maximum hand)	1	10.20
Cadlu	23L20X	T6902DX	Speedometer head (80 mile luminous dial)	1	11.70
Cagmi	23L22X	T6902FX	Speedometer head (80 mile maximum hand luminous dial)	1	13.70
Wyuch	23Q336X	S6904X	Speedometer head bracket complete	1	1.25
Wyuhm	23Q336A	S6904	Speedometer head bracket	1	.75
Wyupt	23Q336B	S6906	Speedometer head bracket clip	1	.30
Wyvix	F50300X	N6912X	Speedometer head glass spun in ring and bezel	1	1.00
Wyvub	20Q311X	S6914X	Speedometer driving cable with casing (31")	1	5.00
Wyvwe	20B871	S6916	Speedometer driving cable casing frame clip	1	.10
Wywiz	20Q318X	S6918X	Speedometer driving cable with upper connection	1	2.75
Wywuc	20Q319	S6920X	Speedometer driving cable casing (31" long)	1	2.50
Wyzaz	F50330	N6922	Speedometer driving cable upper connection	1	.35
Wyzdo	F50350	N6924	Speedometer driving cable lower connection	1	.15
Wyzic	20Q312X1	S6926X	Speedometer pinion with elbow and bracket complete (22 T pinion)	1	3.30
Cahdi	25Q341X1	S6926TX	Speedometer pinion with elbow and bracket complete (26 T pinion)	1	3.30

Order by Number.

Give Motor Number.

Use order blanks which will be furnished on application

Code	Factory No.	Part No.	DESCRIPTION	No. Used	Price Each
Wyzuf	25Q344X1	T6926X	Speedometer pinion with elbow and bracket complete (23 T pinion)	1	\$3.30
Cahiq	25Q349X1	S6926SX	Speedometer pinion with elbow and bracket complete (27 T pinion)	1	3.30
Yaacs	20Q312X	S6928X	Speedometer pinion with elbow (22T pinion)	1	2.15
Cahly	25Q341X	S6928TX	Speedometer pinion with elbow (26T pinion)	1	2.15
Yaahy	25Q344X	T6928X	Speedometer pinion with elbow (23T)	1	2.15
Cahtu	25Q349X	S6928SX	Speedometer pinion with elbow (27T)	1	2.15
Yaamd	20Q316X	S6930X	Speedometer pinion universal bracket (only) complete	1	1.25
Yaarj	20Q320	S6934	Speedometer pinion (22 teeth)	1	.50
Caihlm	25Q341	S6934T	Speedometer pinion (26 teeth)	1	.50
Yaatl	25Q344	N6934K	Speedometer pinion (23 teeth)	1	.50
Caint	25Q349	S6934S	Speedometer pinion (27 teeth)	1	.50
Yabar	19Q301	S6935	Speedometer pinion key	1	.10
Yabov	F50390	N6940X	Speedometer split gear (72 teeth)	1	1.50
Yabse	K50390X	N6940KX	Speedometer split gear (85 teeth)	1	1.50
Yabyx	F50395	N6942	Speedometer split gear clamp	2	.15
Yacet	F50400	N6944	Speedometer split gear clamp screw	4	.05
Yacsa	F50405	N6946	Speedometer split gear spoke clip	5	.05
Yacux	F50410	N6948	Speedometer split gear spoke clip screw	5	.01
Yaczy	F50415	N6950	Speedometer split gear spoke clip screw nut	5	.01

SADDLE GROUP

1920-22-23-24-25-26

(For 1921 saddles see page 77)

Yadve	19Q401	S7000X	Saddle complete 1920	1	\$7.00
Yaect	22Q413X	S7000RX	Saddle complete (Persons) 1922-23-24	1	7.00
Apyrg	24Q416X	S7000TX	Saddle complete (Mesinger) 1924	1	7.00
Apyzi	25Q419X	S7000UX	Saddle complete (Mesinger) 1925	1	7.00
Caime	26Q438X	S7000V	Saddle complete (Mesinger) 1926	1	8.00
Yield	20C59	S7003	Support plate 1920	1	.60
Apzmi	25C32	S7003U	Rear support plate bracket 1925	1	.25
Cairf	25C104	S7003V	Rear support bracket 1926	1	.25
Yaeng	E33555	N9148	Support bracket screw 1920-25-26	2	.06
Adicq	19B114S	N214	Support bracket screw lock washer 1920-25-26	2	.01
Yaerk	18B21	N7026K	Front connection 1920	1	1.00
Caisp	25C105	S7026V	Front connection 1925-26	1	.50
Yafav	18A122	N7028K	Front connection screw 1920	1	.08
Arbni	25B149	S7028T	Front connection bolt 1925 (first type)	1	.10
Arbex	25B326	S7028U	Front connection bolt (late type) 1925-26	1	.10
Adfye	19A58	N211	Front connection bolt nut 1920-25-26	1	.03
Adicq	19B114S	N214	Front connection bolt nut lock washer 1920-25-26	1	.01
Yafoz	20B430	S7007	Support rear clip right 1920	1	.30
Yafva	20B431	S7011	Support rear clip left 1920	1	.30
Yafzo	20Q403	S7015	Support rear clip and support plate screw 1920	2	.10

Order by Number.

Give Motor Number.

Use order blanks which will be furnished on application

Code	Factory No.	Part No.	DESCRIPTION	No. Used	Price Each
Yagiz	20Q404	S7019	Support rear clip and support plate screw nut 1920	1	.03
Afttu	19B115S	N1960	Support rear clip and support plate screw nut lock washer 1920	2	.01
Yaguc		S7023	Bridge 1920-22-23-24	1	.50
Arbty		S7023U	Bridge 1925-26	1	.50
Yagye		S7027	Spring right (Persons) 1920	1	.40
Arbyc		S7027R	Spring right (Persons) 1922-23	1	.40
Arcej		S7027U	Spring right (Mesinger) 1924-25-26	1	.40
Yahoc		S7029	Spring left (Persons) 1920	1	.40
Yakez		S7029R	Spring left (Persons) 1922-23	1	.40
Ardry		S7029U	Spring left (Mesinger) 1924-25-26	1	.40
Yajbt	K30755	N7006	Bridge clips		.10
Yalac		S7059R	Bridge and spring nuts 1920-22-23-24-25-26	2	.05
Afttu	19B115S	N1960	Bridge and spring nut lock washer (Persons) 1920-22-23-24	2	.01
Arefu		N7020Q	Bridge and spring nut lock washer (Mesinger) 1924-25-26	2	.05
Yailf		S7039	Spring and bracket bolt 1920-25-26	2	.10
Yailf		S7039	Spring and truss bolt 1922-23-24	2	.10
Ybsit		N7345Q	Spring and bracket bolt nut 1920-25-26	2	.03
Ybsit		N7345Q	Spring and truss bolt nut 1922-23-24	2	.03
Adicq	19B114S	N214	Spring and truss bolt nut washer	2	.01
Yajic		S7045R	Pommel (Persons) 1922-23-24	1	.15
Areli		S7045T	Pommel (Mesinger) 1924	1	.15
Ybkaj		T7327	Pommel bolt 1922-23-24	1	.15
Ybmal		N7345Q	Pommel bolt nut 1922-23-24	1	.03
Adicq	19B114S	N214	Pommel bolt nut lock washer 1922-23-24	1	.01
Yajza		S7049R	Right truss (Persons) 1922-23-24	1	.20
Aremj		S7049T	Right and left truss (Mesinger) 1924	2	.20
Yakba		S7051R	Left truss (Persons) 1922-23-24	1	.20
Yakec		S7053R	Inside clamp plates (Persons) 1922-23-24	2	.10
Ybwoz		T7433	Inside clamp plates (Mesinger) 1924	2	.10
Yakid		S7055R	Outside clamp plates (Persons) 1922-23-24	2	.10
Arghu		S7055T	Outside clamp plates (Mesinger) 1924	2	.10
Yakug		S7057R	Clamp bolt (Persons) 1922-23-24	1	.10
Ybyfo		T7435	Clamp bolt (Mesinger) 1924	1	.10
Yalac		S7059R	Clamp bolt nut (Persons) 1922-23-24	1	.05
Argny		N7018	Clamp bolt nut (Mesinger) 1924	1	.05
Aricu		N7020	Clamp bolt nut lock washer (Mesinger) 1924	1	.10
Ybmal		N7345Q	Front top bolt nut	2	.03
GENERATOR GROUP					
Yamho	20Q750X1	S7100X1	Generator complete with pulley and bracket 1920-21	1	\$32.50
Yamky	25C58X1	S7100RX1	Generator complete with pulley and bracket 1922-23-24-25-26	1	32.50
Yamuj	20Q750X	N7100Q	Generator only	1	30.00
Yanaf	20C148	S7102	Generator bracket 1920-21	1	1.25

Order by Number.

Give Motor Number.

Use order blanks which will be furnished on application

	No.	No.		Used	Price Each
Yanfa	22C73X	S7102RX	Generator bracket complete 2-23-24-25-26	1	\$2.50
Yanjo	22C73	S7102R	Generator bracket only 1922	1	1.25
Yange	25C56	S7102S	Generator bracket only 1923-24-25-26	1	1.25
Yanoj	20B605	S7103	Generator bracket frame clamp 1920-21	1	.50
Yanyl	22B264	S7103R	Generator bracket frame clamp 1922-23-24-25-26	1	.50
Yaojd	E60180	S7104	Generator bracket frame clamp screw	2	.10
Afttu	19B115S	N1960	Generator bracket frame clamp screw lock washer	2	.01
Yaonj	20B615	S7107	Generator bracket strap 1920-21-22	1	.20
Yaopk	23B71	S7107S	Generator bracket strap 1923-24-25-26	1	.20
Yaorm	20B766S	S7109	Bracket strap upper screw	2	.03
Yaozt	E60320	N9036	Bracket strap lower screw	1	.10
Afttu	19B115S	N1960	Bracket strap lower screw lock washer	1	.01
Yapij	20B616	N7114Q	Generator pulley	1	.75
Yapij	20B616	N7114Q	Generator driving pulley	1	.75
Yapmy	20B811S	S7115	Driving pulley key	1	.02
Yapul	20B612	S7119	Driving pulley shaft	1	.45
Adfye	19A58S	N211	Driving pulley shaft nut	1	.03
Yarek	D35530	N5192	Driving pulley shaft nut washer	1	.03
Yarja	20B787	S7140	Generator belt (wire)	1	.35
Yarmo	21B86	S7140R	Generator belt (leather)	1	.50
Yaryp	20C172X	S7144X	Generator belt guard	1	1.25
Yasel	20B728	S7147	Generator belt guide	1	.10
Yasle	18A185	S7149	Generator belt guide rivet	5	.01
Yason	20B610	S7151	Generator drive gear	1	1.00
Yatal	20B882S	S7155	Generator drive gear key	1	.02
Yatla	20B611	S7161	Generator drive intermediate gear	1	1.50
Yatop	20B613	S7165	Generator drive intermediate gear shaft	1	.25
Yatry	24C5 & 6X	S7169X	Generator drive gear case right and left half	1	2.50
Yauhd	20B614	S7177	Generator drive gear case bushing	4	.25
Yaurn	16A99	S7179	Generator drive gear case dowel	2	.02
Yauxt	20B767S	S7185	Generator drive gear case screw long	3	.03
Yaven	A14140	N1408	Generator drive gear case screw nut	3	.01
Akosh	19B112S	N2808	Generator drive gear case screw nut lock washer	3	.01
Yavma	20B706S	S7109	Generator drive gear case screw short	1	.03
Yavsy	20B41	S2223	Generator drive gear case anchor stud	2	.03
Akapo	A28160	N2252	Generator drive gear case anchor stud nut	2	.03
Alemo	19B113S	N736	Generator-drive gear case anchor stud nut lock washer	2	.01
Wypir	18A99X	N7172	Cable connection block 1920-21-22-23-24	1	.40
Wyppa	A6110	N7176	Cable connection block screw 1920-21-22-23-24	2	.03
Awzyl	A6210	N2804	Cable connection block screw nut 1920-21-22-23-24	2	.03
Wyput	19B111S	N2220	Cable connection block screw nut lock washer 1920-21-22-23-24	2	.01

Order by Number.

Give Motor Number.

Use order blanks which will be furnished on application

Code	Factory No.	Part No.		No. Used	Price Each
Awmtu	D34370	N862K	Cable connection block cable binding screw 1920-21-22-23-24	1	\$.01

SADDLE POST GROUP

1922-23

Ybavt	22C82X	S7250RX	Saddle post assembly	1	\$4.00
Ybbic	22C103	S7254R	Saddle front hinge connection	1	1.50
Ybbuf	22B166	S7258R	Saddle front hinge connection bolt	1	.20
Ybbza	A1320	N1642	Saddle front hinge connection bolt nut	1	.05
Ybcec	21B60	S7262R	Saddle front hinge connection retaining bolt	1	.10
Ybcla	A1250	N234	Saddle front hinge connection retaining bolt nut	1	.03
Ybcug	21B61	S7266R	Saddle post spring plunger	1	1.35
Ybdac	21B63	S7270R	Saddle post spring plunger bushing	1	.30
Ybduh	21B65	S7274R	Saddle post recoil spring	1	.15
Ybexy	21B62	S7278R	Saddle post recoil spring adjusting nut	1	.35
Ybflo	21B64	S7282R	Saddle post compression spring	1	.30
Ybgaf	21B87S	S7286R	Saddle post compression spring adjusting nut	2	.05

SADDLE GROUP

MESINGER AIR CUSHION 1921

Ybhag	21Q407X	S7300QX	Saddle complete (Mesinger Air Cushion)	1	\$10.00
Ybhul	3B	N7305Q	Pommel	1	.15
Ybigh	3	N7310Q	Pommel bolt	1	.10
Ybilm	1	N7315Q	Adjusting screw	1	.05
Ybizb	1B	N7320Q	Tension spring cap	1	.05
Ybjik	G30570	N7325Q	Pommel bolt nut	1	.10
Ybkyp	56	N7330Q	Cantel	1	.50
Yblel	F30695	N7335Q	Stay spring	1	.40
Yblon	5	N7340Q	Stay spring bolt	2	.05
Ybmal	5A	N7345Q	Stay spring bolt nut	2	.03
Ybmin		N7347Q	Stay spring bolt nut washer	2	.03
Ybmyr	75	N7350Q	Yoke post	2	.50
Ybnip		S7355Q	Yoke post clip	2	.10
Ybobd		N7357Q	Yoke post clip bolt	2	.05
Ybohk	5A	N7345Q	Yoke post clip bolt nut	2	.03
Yboln	77	N7360Q	Top cups	2	.35
Ybovy	78	N7365Q	Bottom cups	2	.35
Ybpan	79	N7370Q	Leather and iron washer	2	.20
Ybpor	82	N7372Q	Top leather washer	2	.02
Ybpyt	83	N7375Q	Center post	2	.25
Ybsca	83A	N7380Q	Center post nut	2	.10
Ybsit	5A	N7345Q	Center post top nut	4	.03
Ybsyx	4	N7385Q	Compression spring	2	.30
Ybtas		N7390Q	Attaching bracket right	1	.50
Ybtiv		N7395Q	Attaching bracket left	1	.50

Order by Number.

Give Motor Number.

Use order blanks which will be furnished on application

	No.	No.	DESCRIPTION	No. Used	Price Each
Ybuhl		N7410Q	Attaching bracket bolt	2	\$.10
Ybulp		N7415Q	Attaching bracket bolt nut	2	.05
Yburv		N7420Q	Attaching bracket bolt nut washer	2	.05
Ybyuc	20C59	S7003	Saddle support plate	1	.60
Egsty	E33555	N9148	Saddle support plate and frame screw	1	.06
Abicq	19B114S	N214	Saddle support plate and frame screw lock washer	1	.01

Order by Number.

Give Motor Number.

Use order blanks which will be furnished on application

Special Equipment

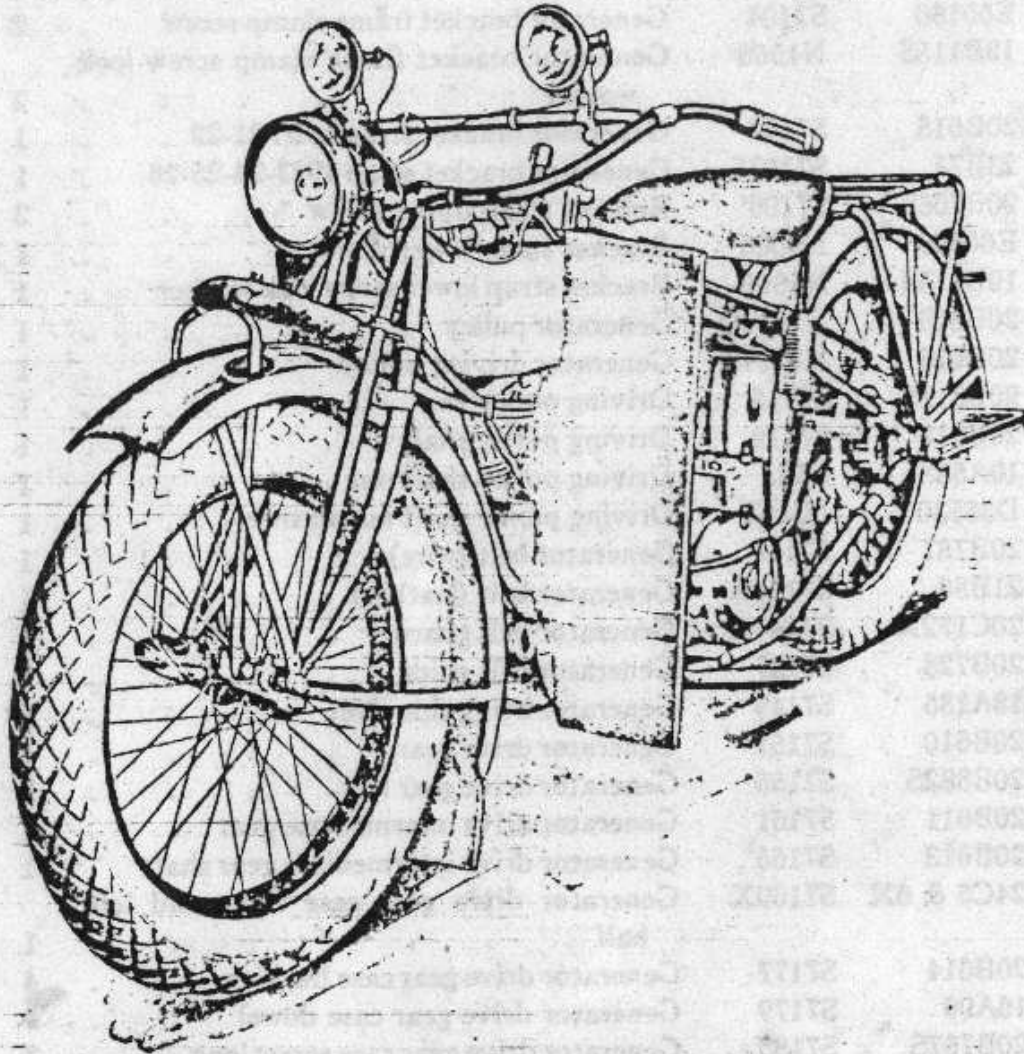

*That Adds to the Comfort
and Pleasure of*

MOTORCYCLING

INDIAN MOTORCYCLE COMPANY
Springfield, Massachusetts

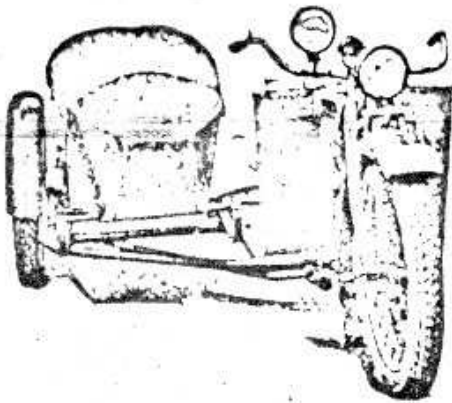

LEG SHIELDS

A real motorcycle leg shield. Something new for the comfort and protection of the motorcycle rider. Made from durable, high quality leatherette. Anchor support brackets are trim in appearance, clever in design and readily fitted. Can be easily dismantled, rolls into small package. Readily carried in sidecar or strapped on luggage carrier.

- 25Q879X Leg shields complete with brackets, Scout and Chief models..... \$5.00
- 25Q878X Leg shields complete with brackets, Prince models..... 5.00



LEGAL LENS

Monogram lens. Legal in every state in the Union and in Canada. Affords ample road illumination for night riding.

- 24Q127 Monogram lens.....6 1/4" \$0.95
- 24Q126 " "6 1/2" 0.95



AN INDESTRUCTIBLE BATTERY

At last a battery that is vibration proof. Furnished as standard equipment on Indian Motorcycle. The new indestructible Wico battery is as solid as a rock and so constructed as to defy vibration. It will stand up and take the worst kind of punishment regardless of how hard a rider may be astride the motorcycle. Furnished in two sizes.

- T6750X Wico battery, 5 N type, 6 volt 20 ampere hour for Chief models..... \$14.00
- N6781SX Wico battery, 3 N type, 6 volt 16 ampere hour for Scout and Standard models..... 11.50

GASOLINE INJECTOR

Gasoline injectors are supplied for all type machines. Quite a handy article to have.

- N1250PX Gasoline tank injector for Chief, Scout and Standard models... \$1.35
- V1250X Gasoline tank injector for Prince models..... 1.15

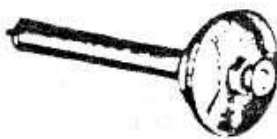

CHAIN TOOL

Low in price but does the work nicely. Can be conveniently packed in tool equipment.

- N5434M Chain tool..... \$0.40

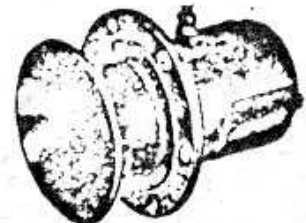
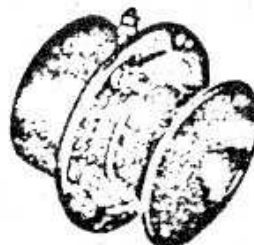

HORNS

Motor driven horn, black Japan finish. Makes an excellent motorcycle warning signal.

- N6850Q Motor driven horn..... \$5.75
- N6850QX Motor driven horn complete with bracket and switch..... 6.75

Buzzer type horn as illustrated, free from rattle, sturdily constructed, meets all requirements.

- S6850S Horn only..... \$3.00
- S6850SX Horn complete with bracket and switch..... 4.00

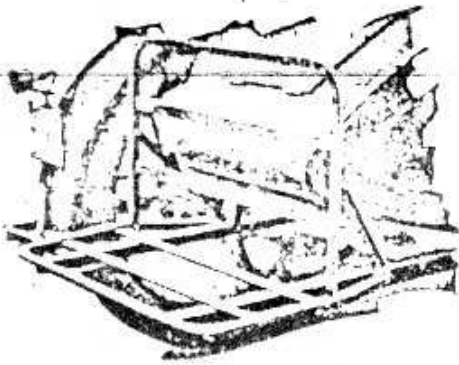

SIDECAR LUGGAGE CARRIER

Here is a sidecar luggage carrier designed to carry luggage safely and securely, easy to attach to the sidecar. Price easy on the rider's pocketbook.

25Q732 Sidecar luggage carrier..... \$5.00

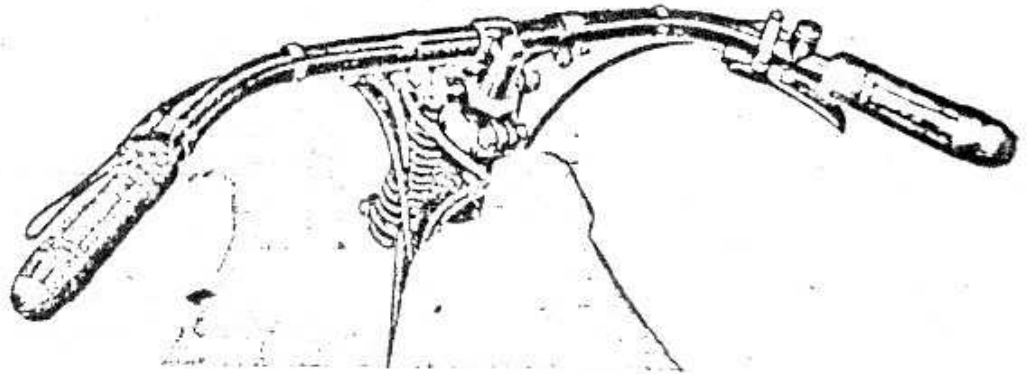

SPORT BARS
(Semi-Racing Type)

Very sturdy, giving the riding position desired by many riders. Indian construction throughout.

20E72X1 Handlebar complete with controls for Scout, Chief and Standard models... \$20.00

25E50X1 Handlebar complete with controls for Prince model..... 16.00

INDIAN OIL

Indian oil—in a new ATTRACTIVE PACKAGE. Handy, Convenient and Safe. Say good-by to happy-go-lucky lubrication.

SPEEDOMETER

Corbin-Brown speedometer used as standard equipment on Indian Motorcycles. This speedometer is also supplied with maximum hand, luminous dial and one hundred mile dial. The maximum hand registers the highest speed traveled and is quite essential for police work or where a check is desired on the maximum speed obtained. Luminous dial permits easy reading of speedometer at night.

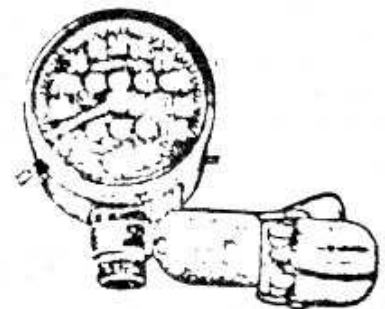

- Speedometer, regular model..... \$17.00
- Speedometer with maximum hand..... 19.00
- Speedometer with luminous dial..... 20.50
- Speedometer with maximum hand and luminous dial..... 22.50

One hundred mile dial, \$1.00 extra.

Specify model when ordering and state tire size.

AIR DRYING ENAMEL

Very handy for enamelling or touching up scratches on frame, tanks, mud guards, etc. Every rider should have a small can. Keep your machine looking good and you will enjoy it more.

- Quarter pint cans..... List \$0.40
- Half pint cans..... List .75
- Pint cans..... List 1.15
- Quart cans..... List 2.00

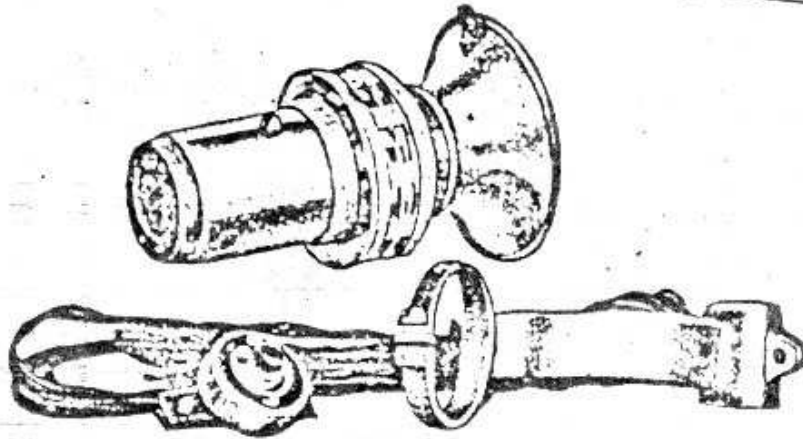

SIREN

A distinctive signal limited to the use of Police and Fire Departments. High pitch, penetrating volume which insures immediate right of way. Beautifully finished. Furnished with push button and motorcycle handlebar bracket.

- 25Q215X Complete as Illustrated.....\$30.00

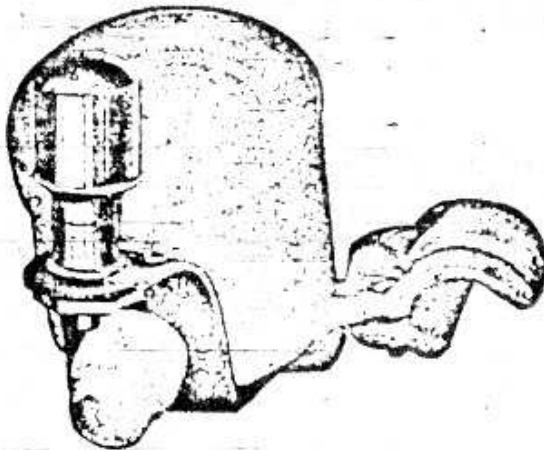

- 25L2X..... \$2.00

NEW SPEEDOMETER LIGHT

Every rider who uses his machine at night, not only should have one of these lights, but really needs one, in fact, in this day of speed traps, traffic regulations, cops patrolling the roads and all that sort of thing, it is absolutely imperative that every rider should know how fast he is going, day or night, and he can only tell by guess at night if he doesn't have a light like this one.

It's made especially to fit the Corbin-Brown Speedometer and there's no trick about it—easy to attach and it stays put. No rattling or slopping around and always on the job. A well-made, classy-looking job too.

The light bracket is so designed that when attached, the handlebar of the motorcycle in turning will not hit the speedometer light, the switch can be placed in whatever position desired by loosening the lock-nut under the light and setting switch lever to desired position.

MUFFLER CUTOUTS

Readily fitted to Scout and Chief models. A hack saw, drill and hammer are all the tools required to assemble this cutout.

- 220826 Muffler cutout for Chief..... \$3.00
- 25Q883 Muffler cutout for Scout..... 3.00

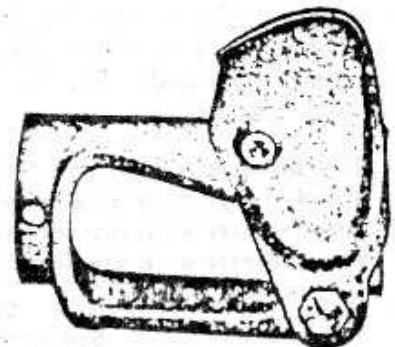

AMMETERS

A watch dog for your electrical system. Registers the rate of charging and immediately notifies you of any short circuit in the electrical system.

- S6860X Ammeter complete with bracket, switch and cables assembled, for Scout models.....\$10.00
- T6860X Ammeter complete with bracket switch and cables assembled, as illustrated for Chief models..... 10.00
- S6860SX Ammeter complete with bracket, as illustrated..... 4.00

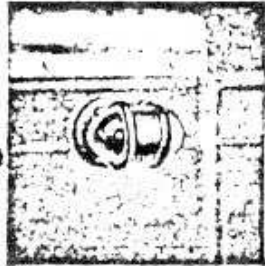
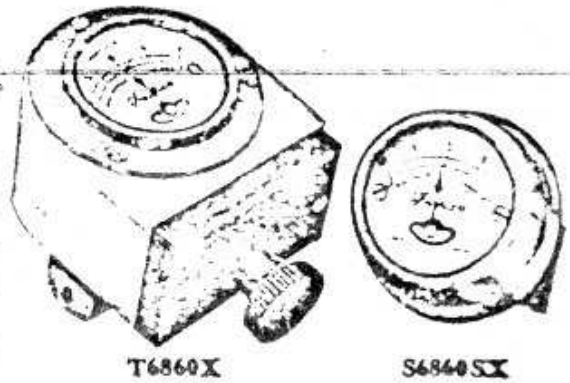

SIDECAR LAMP

Electric sidecar lamp with self contained switch. A very neat and attractive job. Can be very readily attached. White front lens and red rear. Black Japan finish.

- 25Q163X Sidecar lamp with switch \$2.00

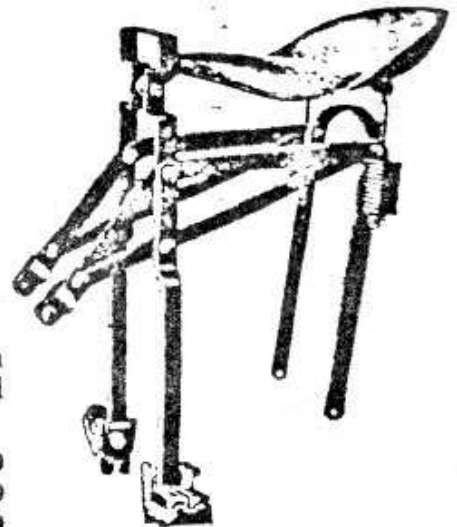

TANDEMS

The most popular tandem on the market. Combines in the highest degree the most essential features of comfort and durability and ease of attachment.

- 25Q514 Tandem complete for Chief model.....\$15.00
- 25Q515 Tandem complete for Scout model..... 15.00
- 25Q517 Tandem complete for Prince model..... 15.00



TIRE PUMP

This is a convenient tire pump, easily attached to the fork side or frame tube by means of special clips, which can be obtained when ordering pump.

- N5430 Pump..... \$1.25
- N5426 Pump clips, per pair..... .25

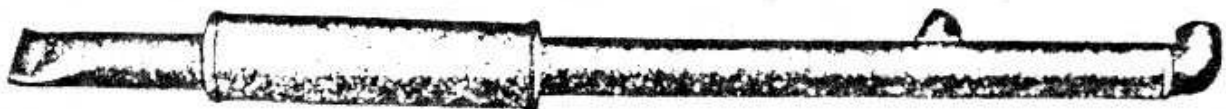

SPECIAL MUFFLER

For all Chief models. Designed to eliminate all exhaust noises without creating back pressure.

- 22E83X1 Special Chief muffler..... \$7.00

ALUMINUM PISTONS

Aluminum pistons made from special alloy and of Indian design.

- Pistons complete with floating wrist pins and rings, per set..... \$12.00

Specify model when ordering

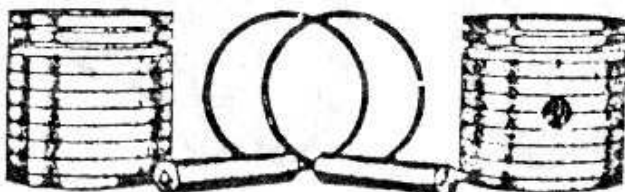

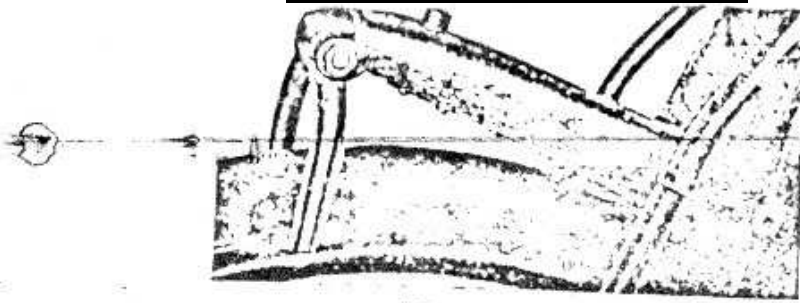

SPRING OILER

This spring oiler provides proper and constant lubrication for front fork spring. Prevents water, dust or dirt from penetrating between the spring leaves. Insures the maximum of riding comfort. Furnished for Scout models and 1924-1925-1926 Chiefs.

25Q882 Fork spring oiler..... \$1.25

WOOLSKIN SADDLE TOP

The use of these saddle covers is becoming universal. They are made from genuine sheep skins which have been cured with full length wool left on and there is no denying that they add much to the rider's comfort. The manner of attaching the Woolskin top is very simple. We have provided a leather pocket at the rear which is drawn over the back of the saddle top requiring no lacing. The point is then slipped over the pommel and secured in position by a draw string.

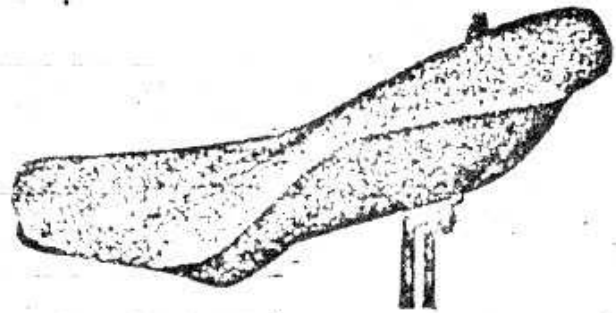

25Q428 Woolskin top for flat top saddles..... \$3.25
 25Q429 Woolskin top for "Bucket" top saddles..... 3.50

SIDECAR WIND SHIELD

The Indian All Weather wind shield. Adds to the pleasure of sidecar riding and affords complete protection for sidecar passenger against all weather conditions. Built from the best materials obtainable, readily attached to the sidecar, easily adjusted and does not interfere in any way with opening the sidecar door and entrance or exit of passenger.



25Q704X Sidecar wind shield..... \$15.75

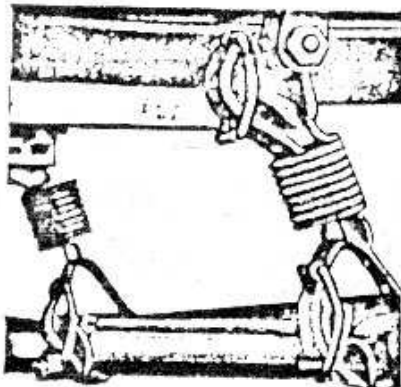

SHOCK ABSORBERS

Sidecar shock absorbers. Check spring rebound, prevent sidecar sway and insure greater riding comfort.

17B105X Sidecar shock absorbers, per pair..... \$2.00

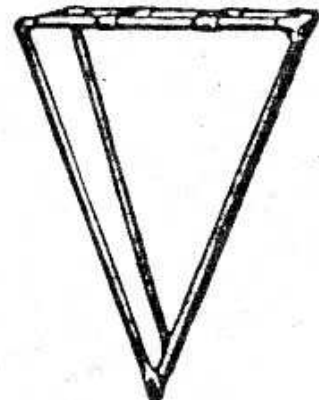

MOTORCYCLE LUGGAGE CARRIER

A very useful accessory. Supplied for all models.

S4600TX Luggage carrier complete for Scout and Prince models..... \$5.50
 T4600TX Luggage carrier complete for Chief models..... 6.00
 N4600RX Luggage carrier complete for Standard models..... 6.00



TOURIST



SPORT COAT



ATHLETE

INDIAN DE LUXE SPORT COAT

Specially designed for us for all year 'round use. Nifty and dressy and the most serviceable sport coat made. Faultlessly prepared to permit utmost freedom of body. Fits snugly, but does not bind. Banded wrists protect the rider from wind and cold. Guaranteed all wool and of finest workmanship. Two breast pockets are provided, with the script letters INDIAN on the flap of left breast pocket. This model comes only in grey body, with collar, cuffs and band at bottom in Indian red. Sizes: 36-38-42-44.

Price..... \$7.00

INDIAN JERSEYS

THE TOURIST: This type of jersey with the rolled buttoned collar was added to our line last year and met with instant popularity with both dealers and riders. Designed for the rider who wants a little more of the dress-up appearance than that afforded by the athlete. It is guaranteed strictly all wool and comes only with Indian Red and white Script INDIAN across the chest, as shown in the illustration. Sizes: 36-38-40-42-44.

THE ATHLETE: This jersey has the comfortable open neck and possesses every quality that a rider wants for warmth, freedom of movement and good appearance. It has always been a popular style with motorcycle riders. Made of the finest grade of wool and guaranteed. Furnished only with Indian Red body and white script letters INDIAN on breast. Sizes: 36-38-40-42-44.

Tourist type..... \$5.50
Athletic type..... 5.00

RIDING BELT

These body belts have won high favor among the motorcycle riders and their use is steadily spreading. A high degree of comfort and restfulness is given those muscles not exercised in riding, and the internal organs are protected. These belts are made of genuine grain leather of agreeable texture and fine finish. They are especially low on the sides and high on the back and front. The straps are free from holes and the buckles are of the designs used on the best trousers belts, holding the straps flat. These buckles clamp the strap at any desired tension, giving the utmost comfort.

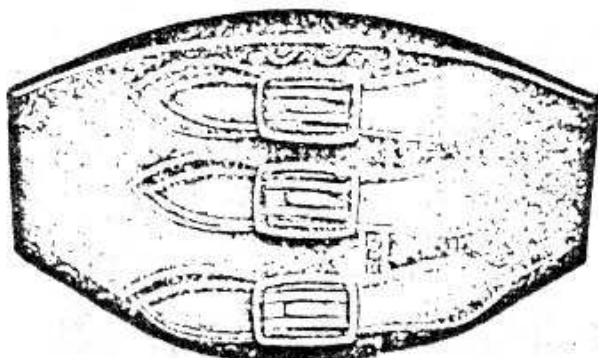

25Q893 Riding belt..... \$4.75

PARKING LIGHT

Fits flush with the fender. Mounting screws and connection are concealed. Due to its rounded lines and low mounting is not liable to be caught by passing objects. Has a readily accessible but concealed switch. Imported ground jewel lense reflecting rays of light and gives the same results as a very large lamp. Standard two candle power 6-8 volts, double contact bulbs are used.

- 22Q161X Japan finish..... \$1.50
- 22Q162X Nickel finish..... 1.75

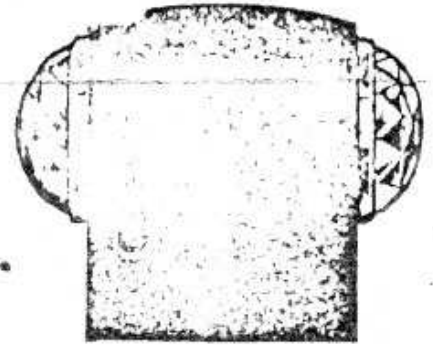

SPOT LIGHT

Indian spot light. Special Indian design. An exceptionally convenient light. Sturdy metal switch and mounted on an adjustable bracket, affording full range of use on any type handle bar. Black Japan finish with heavy nickel plated trimmings.

- 25Q176X Spot light complete with bulb, bracket and cable..... \$4.00

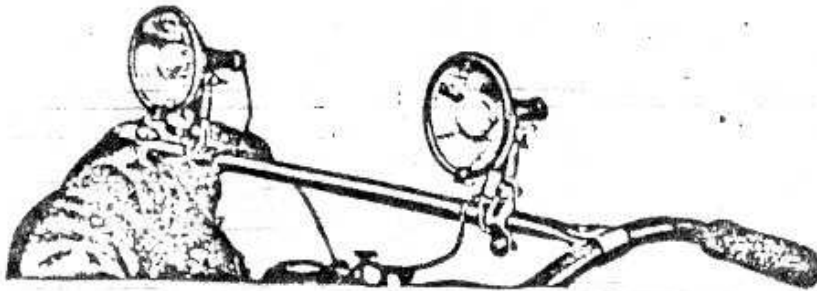

CROSS BAR

This handlebar cross bar makes an ideal mount for horn, spot light, mirror, etc. It is made from high quality seamless steel tubing. Nickel finish. Furnished in three sizes.

- 25Q892X Cross bar complete with clamps, 23 1/4" long..... \$2.50
- 25Q891X Cross bar complete with clamps, 22 1/2" long..... 2.50
- 26W11X Cross bar complete with clamps, 25 1/4" long. For 1926 Bars..... 2.50

PEDAL PADS

Insure positive tread for the feet when actuating clutch or brake pedal. Easy to attach, slip right over the pedal and stay put. Worth their weight in gold.

- 25Q885 Pedal pad for Chief and Scout clutch pedals and Scout and Prince foot brake pedals..... \$0.25
- 25Q886 Pedal pad for Chief and Standard foot brake pedals. Also Standard clutch pedal..... .30

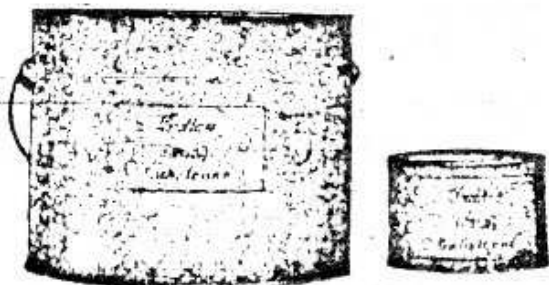
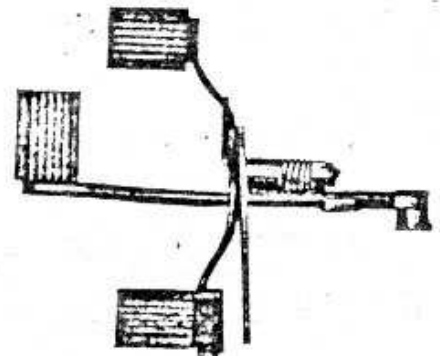

INDIAN GREDAG LUBRICANT

Indian Gredag Lubricant. Elastic and heat resisting. Possesses unique qualities, especially desirable for use in wheel hub bearings. You cannot afford to be without it.

- 25Q880 One pound can..... \$0.40
- 25Q881 Ten pound can..... 3.75

HEAD LIGHT

The latest design for motorcycle use. Uses a double filament bulb registering dim or bright. Furnished with or without switch in lamp. Black Japan finish.

- 86810UX Head lamp complete with switch.. \$6.00
- N6810QX Head lamp complete as used on Chief and Standard models..... 6.00

TAIL LIGHT

- 84820X Tail lamp complete with bracket and switch..... \$1.75

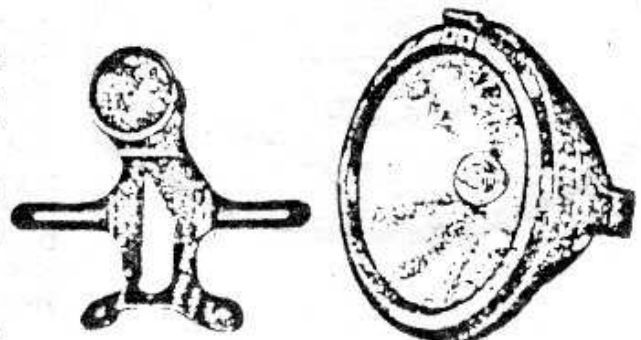

INDIAN SPORT WINDSHIELD—REAL CLASS FOR THE PRINCESS SIDECAR

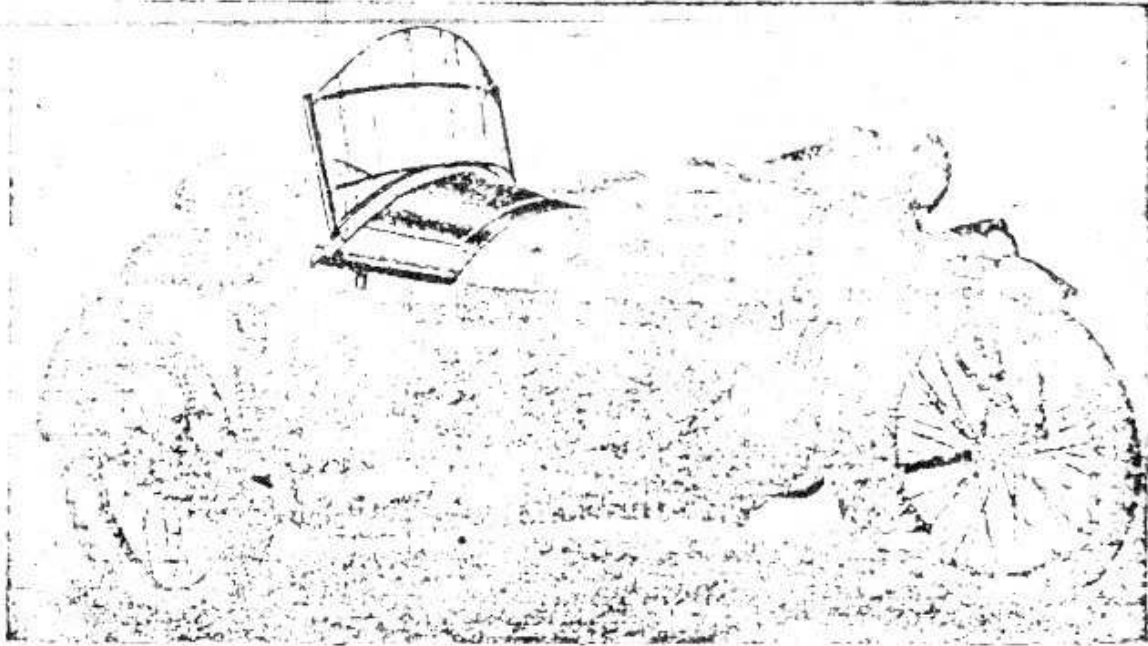

25Q705X.....\$12.00

Indian Sport Windshield is easily attachable. Drill three holes on left side of Princess sidecar and adjust shield with bolts and nuts supplied. Insert fastener for holding down shield deck on door and the outfit is ready to ride. Illustration above shows the shield in riding position. Note the unique cowl effect and the sweeping streamline appearance. Apron may either be rolled inside and strapped into place or may serve as a covering for passenger. When the sidecar is empty, apron fits neatly over back of seat.

"SAVE YOUR TIRES" MOVEMENT IS STARTED BY SECRETARY OF COMMERCE HOOVER

To offset the high prices resulting from the British Rubber monopoly, Secretary Hoover has started a "Save Your Tires" campaign which is a mighty good idea. Many a tire has been cast aside that might have been patched. A "stitch in time" in many a tire now rotting away would have saved it from an early grave. Secretary Hoover estimates that 25 per cent can be added to the average mileage obtained by prompt attention to small injuries which tires suffer in everyday travel, and right now is your opportunity to save both your own tires and those of your riders.

USE WEDFORD KEX TIRE REPAIR PLUGS

This is the very latest method of tire repair and absolutely prevents fabric separations and decay.

Wedford Kex Plugs, for quick and permanent repair of punctured tire casings are easily applied. To repair a puncture, the stem of the Plug is inserted into shank of

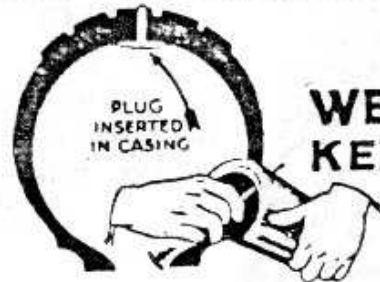

WEDFORD KEX PLUGS

needle. Needle is then pushed through puncture in casing from inside. A little cement on the needle and a pair of pliers makes the job still easier. The stem is then clipped off flush with outside of casing.

Riders' Kits each contain eight assorted Plugs, one tube of cement, a piece of patching rubber for inner tube, and a needle.

List price is \$1.25 (Part No. 26W17)

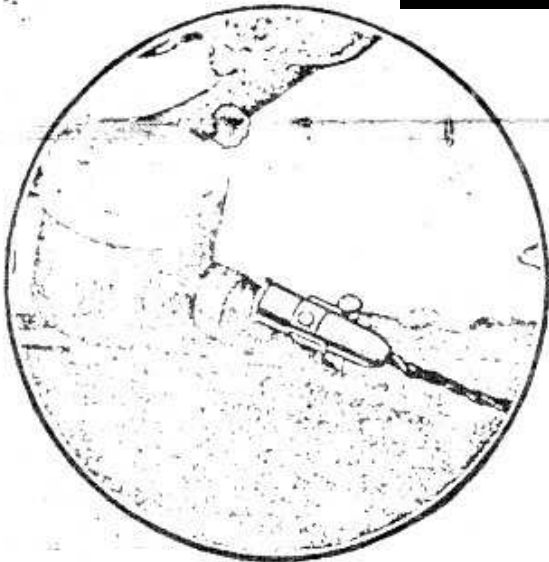

Cigar or Cigarette Lighter
in position for instant use

The Same Lighter with Bulb Inserted
for use as Trouble Lamp

26W4X \$1.50

INDISPENSABLE PROTECTION AND COMFORT FOR THE RIDER'S EYES

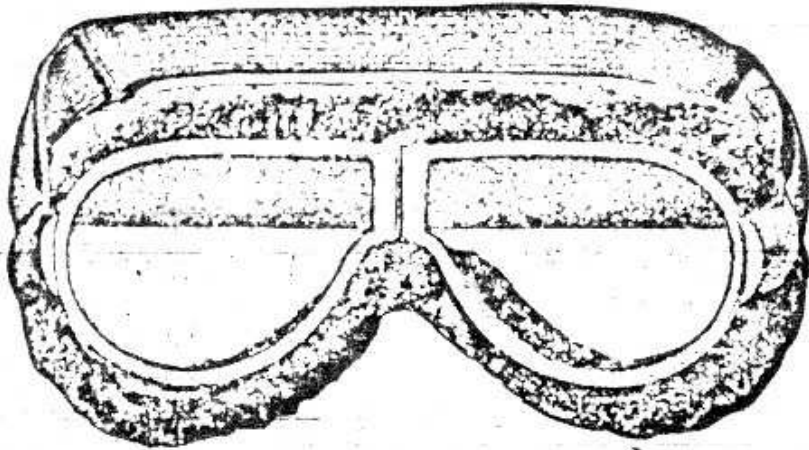

"DG"

is made with vents, Dimmer RESISTAL lenses, a wider hinge and triple chenille.

List Price \$6.00

"NAK"

The Premier RESISTAL
The World's Best Goggle.
Nothing better is possible.
Used Everywhere.

List Price \$5.00

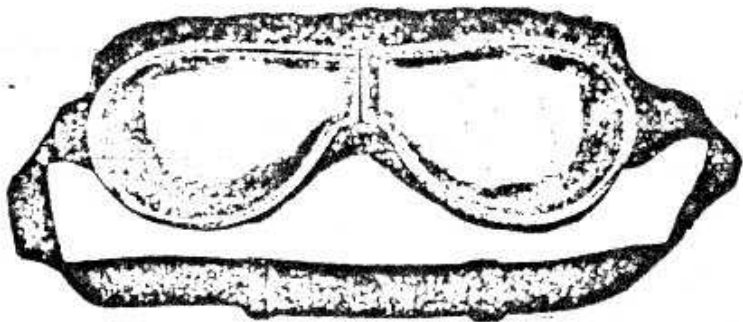

"WYD"

RESISTAL, wide vision,
fabric style, no hinge,
but leather bridge. All
material up to our
standard.

List Price \$3.50

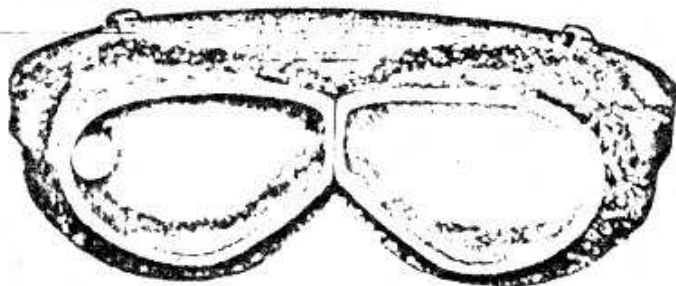

"Touringlas"

French style, chenille
edges, bent glass.

List Price \$1.75

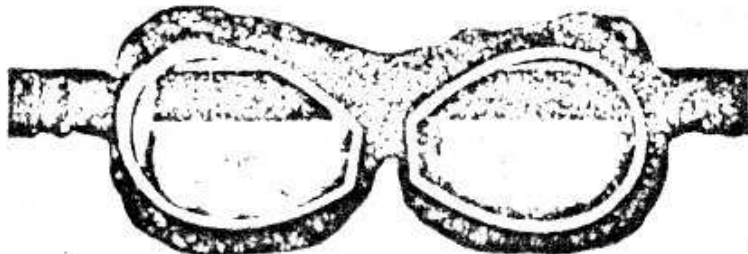

Don't Let 'Em Bump You!

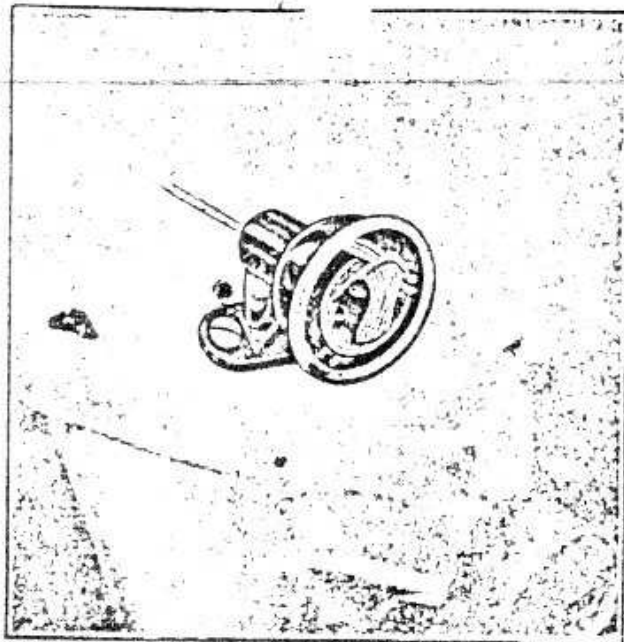

Use an Indian Stop Light

Indian Stop Light is of exclusive Indian design and, as you will note in the illustration, it bears the Laughing Indian Trade Mark. The Light is adjustable so as to be easily attached to either sidecar or motorcycle mud-guard. The switch is everything that the word "simple" implies. It attaches to the frame tube and operates off the brake rod.

The big advantage of this stop light is the ease of attaching not only the light but also the switch which has been especially designed for motorcycle use. Switches previously used with motorcycle stop lights were for automobile use and required a great deal of unnecessary time and labor to adapt.

List price is \$1.75 (Part No. 26Q138X)

MESINGER PERFECT BACKREST

Perfect Backrest affords "perfect" ease and comfort to the motorcycle rider. Constant riding makes it worth its weight in gold to the owner.

Mesinger Perfect Backrests may be attached to Mesinger Bucket Saddles and also the Cushion Suspension No. 3 Types. They list at \$5.

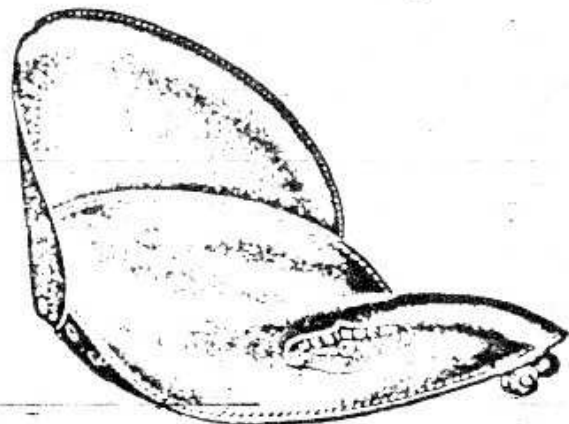

INDIAN FOOT PUMP

17-inch, nickel-plated Indian Foot Pump shown at left. It is of rugged construction and will stand a great deal of abuse. Rubber air tube is tightly adjusted with metal clamps at both ends to insure no air leaks.



25W1..... \$1.50

POLISHED ALUMINUM DISC WHEELS

We are now in a position to supply Polished Aluminum Disc Wheels made of the best grade heavy gauge Aluminum hand spun to fit any make motorcycle. These discs add no perceptible weight to a machine and are absolutely noiseless. They can be easily kept clean and highly polished making for extreme attractiveness to your mount.

Description	List Prices
Discs may be had for 24, 26, and 28 inch wheels.	
Solo outfit (that is, two sets of discs, one for each wheel) for either 26 or 28 inch wheels.....	\$15.00
Solo outfit for 24 inch wheels.....	14.00
Sidecar outfit (that is, three sets of discs, one for each wheel) for either 26 or 28 inch wheels.....	22.50
Sidecar outfit for 24 inch wheels.....	21.00

- Sets Polished Aluminum Discs (Part No. 24Q871) for 28" front wheel
- Sets Polished Aluminum Discs (Part No. 24Q871A) for 28" rear wheel
- Sets Polished Aluminum Discs (Part No. 24Q871B) for 28" sidecar wheel
- Sets Polished Aluminum Discs (Part No. 24Q890) for 26" front wheel
- Sets Polished Aluminum Discs (Part No. 24Q890A) for 26" rear wheel
- Sets Polished Aluminum Discs (Part No. 24Q890B) for 26" sidecar wheel
- Sets Polished Aluminum Discs (Part No. 26W12) for 24" front wheel
- Sets Polished Aluminum Discs (Part No. 26W12A) for 24" rear wheel
- Sets Polished Aluminum Discs (Part No. 26W12B) for 24" sidecar wheel

INDEX

	Page
Accessories	79 to 89
Ammeter and Wiring Group	70
Automatic Oiler Group	44
Battery and Battery Box Group	67
Battery Parts	66
Brake Group, External	53
Breaker	65
Breaker Box	62
Carburetor Group (Schebler)	21
Carburetor Group (DeLuxe)	19
Chain and Chain Guard Group	52
Clutch and Transmission Group	34
Condenser	63
Crank Case Group	11
Cylinder and Piston Group	13
Distributor	66
Exhaust and Inlet Valve Group	14
Field Poles	63
Fly Wheel and Crank Motion Group	8
Foot Board Group	59
Foot Brake Group	52
Frame and Front and Back Plate	65
Frame Group	34
Gasoline and Oil Tank Group	41
Generator Group	75
Goods Returned	5
Guarantee	6
Handle Bar and Grip Control Group	23
Head Fitting Group	26
Head Lamp Group	68
High Tension Winding	62, 65
Horn Group	69
Inlet and Exhaust Valve Group	14
Instructions for Ordering	3
Introduction	3

INDEX—Continued

	Page
Luggage Carrier	56
Magneto S2	63
Magneto, Aero	61
Magneto Gear Group	63
Magnets and Cover	61, 63
Mudguards, Front and Rear	46, 47
Muffler Group	17
Ordering Instructions	3
Plate, Front and Back	61
Primer Group	23
Replacements	5
Return of Goods	5
Rotating Pole Structure	62, 65
Saddle Group, Air Cushion	77
Saddle Group, Bucket Top	73
Saddle Post Group	77
Schebler De Luxe Carburetor	19
Schebler Carburetor Group	21
Service	6
Spark Plug Group	17
Speedometer Group	72
Spring Fork Group	27
Stand, Rear	55
Stand, Front	55
Starter, Kick	57
Tail Lamp Group	69
Terms	5
Tool Box Group	59
Warning	5
Wheels, Front Group	48
Wheels, Rear Group	49